

ydsa



CATÁLOGO

SERVICIO PESADO

**20
26**

MISIÓN



Brindar a nuestros clientes partes automotrices de calidad a un precio accesible, satisfaciendo así sus expectativas gracias a la mejora continua.

VISIÓN

Consolidarnos como una empresa líder en el mercado nacional e internacional, adaptándonos constantemente a los cambios y necesidades de los clientes sin demeritar en la calidad de nuestro producto.

Amado, yo deseo que tú seas prosperado en todas las cosas, y que tengas salud, así como prospera tu alma.

3° Juan 1:2

EPO-078CM

OEM:64697000

GAFF:13582



GRANADA DE BOTELLA T/HENDRICKSON
EXT. 2" LG. 8 1/16"

EPO-092

OEM:46734

GAFF:13517



GRANADA EXCENTRICA HENDRICKSON
EXT. 2 3/4" HO. 13/16" C.C. 5 11/16

EPO-097

OEM:A2297K1052

GAFF:11512



GRANADA TENSOR KENWORTH BIG SIX
EXT. 4 1/8" LG. C-C 4 3/8"

EPO-125

OEM:44695000L

GAFF:13520



GRANADA P/ TENSOR KENWORTH.
EXT. 2 3/4" BARR. 13/16" C.C 4 3/8"

FYD-125N

OEM:44695000L

GAFF:13520



GRANADA P/ TENSOR KENWORTH.
EXT. 2 3/4" BARR. 13/16" C.C 4 3/8"

EPO-126

OEM:24476000

GAFF:11509



GRANADA P/TENSOR HENDRICKSON
EXT. 3 1/2" BARR. 21/32" C-C 4 3/8"

EPO-127

OEM:836940

GAFF:11729



GRANADA BOLA P/TENSOR KENWORTH
EXT. 2 3/4" HO: 11/16 LG.C-C 4 3/8"

FYD-127N

OEM:836940

GAFF:11729



GRANADA BOLA P/TENSOR KENWORTH
EXT. 2 3/4" HO: 11/16 LG.C-C 4 3/8"

EPO-146

OEM:32174000

GAFF:13519



GRANADA TENSOR YOYO HENDRICKSON
EXT. 3 19/32" HO. 21/32 C-C. 4 3/8"

EPO-176

OEM:57256

GAFF:13618



GRANADA P/TENSOR HENDRICKSON
EXT. 2 7/16" HO. 5/8 C-C 4 3/8"

NUCLEOS PARA TENSOR

EPO-155

OEM:51087148

GAFF:13522



GRANADA BARRA TORSION KENWOTH.
EXT. 2 17/32" HO 21/32 C-C 4 3/8"

FYD-155

OEM:51087148

GAFF:13522



GRANADA BARRA TORSION KENWOTH.
EXT. 2 17/32" HO 21/32 C-C 4 3/8"

EPO-157

OEM:A16119448

GAFF:13521



GRANADA P/TENSOR HENDRICKSON.
EXT. 2" HO. 21/32 C-C 4 13/32

FYD-157N

OEM:A16119448

GAFF:13521



GRANADA P/TENSOR HENDRICKSON.
EXT. 2" HO. 21/32 C-C 4 13/32

EPO-157B

OEM:SSR0035P240

GAFF:12051



GRANADA P/TENSOR HENDRICKSON
EXT. 1 31/32" HO. 11/16 C-C 4 3/8"

EPO-157C



GRANADA P/TENSOR C/CEJAS KENWORTH
EXT. 2" LG.C-C 4 3/8"

EPO-168

OEM:K066342

GAFF:11507



GRANADA BARRA DE TORSION KW-T800
EXT. 2 11/16" HO. 21/32 C-C 4 3/8"

EPO-176A

DAI:9188



NUCLEO P/TENSOR HENDRICKSON
EXT. 2 3/8" LG.C-C 4 3/8"

EPO-182

OEM:47691

GAFF:13598



GRANADA P/TENSOR, HENDRICKSON.
EXT. 1 7/8" HO 21/32 C-C. 4 13/32"

FYD-193N

OEM:HRIHBU541

GAFF:11063



PERNO P/BARRA FREIGHTLINER
EXT. 1 3/4" BARR. 21/32"
C-C 5 3/8" LG. 6 3/8"

NUCLEOS PARA TENSOR



EPO-195

OEM:8651006

GAFF:11753



PERNO MUELLE FRONTAL KENWORTH
EXT. 1 3/4" EXT.< 1 1/16"
C.C. 6 5/16" LG. 7 1/2"

FYD-195N

OEM:B651006

GAFF:11753



PERNO MUELLE FRONTAL KENWORTH
EXT. 1 3/4" EXT.< 1 1/16"
C.C. 6 5/16" LG. 7 1/2"

EPO-208CM

OEM:229610

GAFF:13518



GRANADA T/BOTELLA HENDRICKSON,
KENWORTH,
EXT. 2 3/4" ROSCA. 1 1/4" LG. 8 1/16"

EPO-209CM

OEM:46735

GAFF:12031



GRANADA T/BOTELLA HENDRICKSON
EXT. 2 3/4" ROSCA. 1 1/4" LG. 7"

EPO-211

OEM:57256000

GAFF:11714



GRANADA P/TENSOR HENDRICKSON.
EXT. 2 15/32" BARR. 21/32" C-C 4 3/8"

FYD-211N

OEM:57256000

GAFF:11714



GRANADA P/TENSOR HENDRICKSON.
EXT. 2 15/32" BARR. 21/32" C-C 4 3/8"

EPO-212

OEM:476991

GAFF:13515



GRANADA EXCENTRICA HENDRICKSON.
EXT. 3" BARR. 13/16" C-C. 5 11/16"

EPO-214

OEM:1613962000

GAFF:11005



GRANADA FREIGHTLINER, LARGA LISA
EXT. 2 1/2" C-C. 5 21/32"
HO.13/16" LG. 7 1/2"

FYD-214AN

OEM:161641200

GAFF:11083



GRANADA FREIGHTLINER, LARGA ORIJNAL EXT. 2 1/2"
C-C. 5 21/32" HO.7/8" LG. 7 1/2"

EPO-257

OEM:52375

GAFF:11767



PERNO MUELLE FRONTAL KENWORTH
EXT. 1 3/4" EXT.< 1 1/16"
C.C. 5 7/16" LG. 6 5/8"

NUCLEOS PARA TENSOR

EPO-257A

OEM:8651005

GAFF:11758



PERNO P/ MUELLE FRONTAL KW.
EXT. 1 3/4" EXT.<1 1/16"
C-C. 5 3/4" LG.. 7"

EPO-257B



PERNO P/ MUELLE FRONTAL KW.
EXT. 1 3/4" EXT.<1 1/16"
C-C. 5 3/8" LG. 6 5/8"

EPO-290



GRANADA DE BOLA PARA VOLVO
EXT. 2 5/8" BARR. 23/32" C-C 4 3/8"

EPO-341

OEM:47691

GAFF:11004



GRANADA P/SUSPENSION FREIGHTLINER
EXT. 2" HO 11/16" C.C 4 3/8"

EPO-342

OEM:44695

GAFF:13536



GRANADA P/SUSPENSION HENDRICKSON
EXT. 2 15/16" BARR. 21/32" C.C 4 3/8"

EPO-356

OEM:1598588

GAFF:31000



GRANADA BARRA DE TORSION VOLVO
EXT. 3 5/8" BARR. 9/16"

EPO-463

OEM:8651007

GAFF:11763



PERNO MUELLE DELANTERA KENWORTH
EXT. 2 5/64" EXT.<1 1/16"
C.C. 6 5/16 LG. 7 1/2"

EPO-490

OEM:1614603000

GAFF:11094



PERNO P/MUELLE FREIGHTLINER
EXT. 2 1/4" EXT.<1 1/4"
LG.C-C. 5 3/8" LG.6 3/4"

EPO-522

OEM:6440004L

GAFF:34534



GRANADA P/INTERNATIONAL TRUCK
EXT. 2 17/32" LG. 8 1/16"

EPO-533

OEM:



GRANADA BARRA TORSION NEOPLAN
EXT. 2 9/16" C.C. 4 7/8" BARR. 3/4"

EPO-536

OEM:60383000

GAFF:13627



GRANADA BIGA TORSION HENDRICKSON
EXT. 2 1/2" EXT.<45.6MM
C.C. 5 17/32" LG. 7 1/8"

EPO-781

OEM:274069

GAFF:32009



KIT REPARACION BARRA VOLVO BUS
OD: 3 9/16" LG: 2 27/32 HO: 7/8"

EPO-841N

OEM:1104335

GAFF:32007



BUJE P/TENSOR MAN BUS, VOLVO BUS
EXT. 3 5/16" HO. 3/4" C.C. 5 1/8"

EPO-881

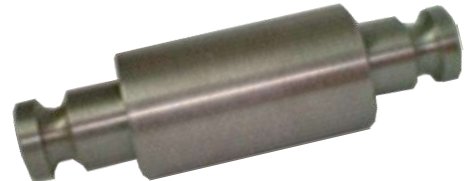

PERNO MUELLE DELANT. KENWORTH
EXT. 2 5/64" EXT.<. 1 1/16"
C. C. 5 3/8" LG. 6 5/8"

EPO-1003

OEM:81432706079

GAFF:32008



GRANADA BARRA DE TORSION VOLVO
OD: 3 23/32" HO: 15/16" C-C: 6"

FYD-1008N

OEM:90008175

GAFF:14532



BUJE PARA SUSPENSION LATERAL NEWAY
EXT. 3 27/32" HO. 1 1/16" C-C: 8 1/2"

EPO- 1018

OEM:8152450

GAFF:31093



GRANADA P/TENSOR VOLVO TRUCK
EXT. 3 19/32" HO 21/32 C-C. 4 17/32"

EPO- 1060

GAFF:11060



PERNO DEL. MUELLE FREIGHTLINER FL
OD: 1 25/32" OD<. 1"
LG C-C: 5 3/4" LG. 7"

EPO- 1135

OEM:3093630

GAFF:31135



GRANADA P/SUSP. VOLVO TRUCK
EXT. 2 15/16" HO.3/4" C.C. 5 1/8"

EPO- 1158

OEM:6440002L

GAFF:11158



GRANADA P/SUSP. HENDRICKSON
EXT. 2 25/32" HO 21/32" C.C 4 3/8"

NUCLEOS PARA TENSOR

EPO-1162

OEM:80480078000

GAFF:11162



GRANADA P/SUSP. FREIGHTLINER
EXT. 3 15/16" HO 29/32" C.C 6 7/8"

EPO-1163

OEM:062480041000

GAFF:11163



GRANADA P/SUSP. FREIGHTLINER
EXT. 2 15/16" HO 21/32" C.C 4 3/8"

EPO-1166

GAFF:11166



GRANADA P/SUSPENSION FREIGHTLINER
OD: 3 11/32" HO: 29/32" C-C: 6 7/8"

EPO-1601

OEM:3502205

GAFF:31601



GRANADA P/SUSP. MERCEDES BENZ BUS
EXT. 2 27/32" HO.1" C.C. 5 1/8"

EPO-1602

OEM:3502405

GAFF:31602



GRANADA P/SUSP. MERCEDES BENZ BUS
EXT. 3 15/16" HO.1" C.C. 6"

EPO-1775

OEM:8656005

GAFF:11775



PERNO MUELLE DELANT. KENWORTH
EXT. 2 1/8" EXT.< 1"
C.C. 5 15/32" LG. 6 3/4"

EPO-1846

OEM:B656005

GAFF:11846



PERNO MUELLE DELANT. KENWORTH
EXT. 2 3/32" EXT.< 1 1/16"
C.C. 5 25/32" LG. 7"

EPO-2056

OEM:81433150009

GAFF:32056



GRANADA P/TENSOR MAN BUS,
EXT. 3 23/32" HO. 3/4" C.C. 5 23/32"

EPO-2083

OEM:271187

GAFF:32083



GRANADA P/SUSP. SCANIA, BUS
EXT. 2 15/16" HO 21/32 C.C 4 17/32

EPO-2086

GAFF:32086



GRANADA P/SUSP. SCANIA, BUS IRIZAR
EXT. 2 5/32" HO 5/8 C.C 3 9/16

NUCLEOS PARA TENSOR



EPO-2088

OEM:20840815

GAFF:32088



GRANADA P/SUSP. VOVO TRUCK
EXT. 3 11/32" HO. 3/4" C.C 5 1/8"

EPO-2316

OEM:1620750

GAFF:12316



GRANADA BARRA TORSION VOVO BUS
OD: 2 9/32" HO: 37/64" C-C: 3 13/16"

EPO-2345

OEM:1135080

GAFF:12345



BUJE P/BARRA DE TORSION VOLVO BUS
OD: 3 5/8" HO: 21/32" LG C-C: 5 1/8"

EPO-3523

GAFF:13523



GRANADA P/SUSP. HENDRICKSON
EXT. 3" HO 13/16" C.C 5 7/8"

FYD-3580N

OEM:3401388L

GAFF:13580



GRANADA LATERAL HENDRICKSON
OD: 4 3/8" C.C. 8 1/2" HO: 1"

EPO-3834

OEM:TS0022500

GAFF:13834



GRANADA P/TENSOR HENDRICKSON
OD: 2" HO: 21/32" C-C: 4 3/8"

EPO-4586

GAFF:34586



GRANADA P/SUSP. INTERNATIONAL
EXT. 2 1/32" INT. 3/4" LG. 4 3/8"

FYD-4536N

OEM:AS5727267

GAFF:14536



GRANADA P/ VIGA NEWAY/SAF
OD: 3 1/8" HO: 1" C-C: 6 1/4"

EPO-4591

OEM:3820005C2

GAFF:34591



GRANADA P/SUSP. INTERNATIONAL
EXT. 2 1/8" HO. 21/32 C.C. 5 3/4"

EPO-4592

OEM:380006C2

GAFF:34592



GRANADA P/SUSP. INTERNATIONAL
EXT. 2 1/8" HO. 21/32 C.C. 4 3/8"

NUCLEOS PARA TENSOR

EPO-8909

OEM:64400003L

GAFF:18909



GRANADA P/SUSP. HENDRICKSON
EXT. 2 3/4" HO 13/16" C.C 5 1/4"

EPO-31087

OEM:274070

GAFF:31087



GRANADA P/SUSP. SCANIA, VOLVO BUS
EXT. 2 15/16" HO.21/32" C.C. 5 1/8"

EPO-40263

OEM:055480040

GAFF:40263



GRANADA P/SUSPENSION FREIGHTLINER
OD: 2 15/16" HO: 25/32" C-C: 4 3/8"

EPO-1856

OEM:A2297K1051



GRANADA P/SUSPENSION KENWORTH
OD: 4 1/8" HO: 7/8" C-C: 5 1/4"

<p>EPO-001</p> <p>OEM:K066-184</p> <p>GAFF:11500</p>	 <p>BUJE CENTRAL P/SUSPENSION T/VIEJO KW EXT. 4 1/2" INT. 3 1/2" LG. 4"</p>	<p>EPO-020</p> <p>GAFF:15020</p>	 <p>BUJE P/TENSOR T/REYCO, KW. EXT. 2 9/32" EXT. 1 23/32 INT. 1" LG. 1 23/32</p>
<p>EPO-020H</p> <p>GAFF:15020</p>	 <p>BUJE P/TENSOR T/REYCO, KW. EXT. 2 9/32" EXT. 1 23/32 INT. 1" LG. 1 23/32</p>	<p>EPO-029</p> <p>OEM: K174-155</p> <p>GAFF: 11535</p>	 <p>SOPORTE TRASERO P/MOTOR KENWORTH W-900 EXT. 4 1/2" ALT. 2" ESP. 1/2"</p>
<p>EPO-029H</p> <p>OEM: K174-155</p> <p>GAFF: 11535</p>	 <p>SOPORTE TRASERO P/MOTOR KENWORTH W-900 EXT. 4 1/2" ALT. 2" ESP. 1/2"</p>	<p>EPO-039</p> <p>OEM:CB1121-10</p> <p>GAFF:11544</p>	 <p>SOPORTE BISAGRA COFRE KENWORTH EXT. 1 3/4" EXT. < 1 1/4" INT. 17/32" ALT. 1 1/4"</p>
<p>EPO-039H</p> <p>OEM:CB1121-10</p> <p>GAFF:11544</p>	 <p>SOPORTE BISAGRA COFRE KENWORTH EXT. 1 3/4" EXT. < 1 1/4" INT. 17/32" ALT. 1 1/4"</p>	<p>EPO-042</p>	 <p>COJIN MUELLE P/FRUEHAUF LG. 6" ANCHO 5" ESP. 5/8"</p>
<p>EPO-069</p> <p>GAFF:11522</p>	 <p>SOPORTE P/CABINA KENWORTH S/HERRAJE EXT. 2 7/8" EXT.< 1 13/16 INT.5/8" ALT. 1 1/4"</p>	<p>FYD-069N</p> <p>GAFF:11522</p>	 <p>SOPORTE P/CABINA KENWORTH S/HERRAJE EXT. 2 7/8" EXT.< 1 13/16 INT.5/8" ALT. 1 1/4"</p>

EPO-069H

OEM:J7165-1

GAFF:11522



SOPORTE P/CABINA KENWORTH, PETERBILT
EXT. 2 7/8" EXT.< 1 13/16 INT.5/8" ALT. 1 1/4"

FYD-069HN

OEM:J7165-1

GAFF:11522



SOPORTE P/CABINA KENWORTH, PETERBILT
EXT. 2 7/8" EXT.< 1 13/16 INT.5/8" ALT. 1 1/4"

EPO-69AH

OEM:K066-228

GAFF:11520



SOPORTE P/CABINA KW-900
EXT. 2 7/8" EXT.< 1 27/32 INT. 5/8" ALT. 1 5/16"

EPO-220



REPUESTO PARA GRANADA
EXT. 2 25/32" INT. 1 3/4" LG. 2 5/8"

EPO-077

OEM:K066-423

GAFF:11615

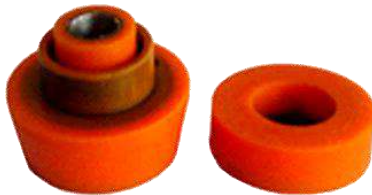

SOPORTE DELANTERO PARA MOTOR KENWORTH
OD: 3 1/2" OD<: 2" ID: 13/16" LG: 2 3/32"

FYD-077N

OEM:K066-423

GAFF:11615



SOPORTE DELANTERO PARA MOTOR KENWORTH
OD: 3 1/2" OD<: 2" ID: 13/16" LG: 2 3/32"

EPO-098

OEM:660551

GAFF:18102



SOPORTE DELANT. P/MOTOR WESTERN STAR, KENWORTH
EXT. 3 5/8" EXT. 2 3/16" INT. 3/4" ALT. 2 15/32"

EPO-098H

OEM:660551

GAFF:18102



SOPORTE DELANT. P/MOTOR WESTERN STAR, KENWORTH
EXT. 3 5/8" EXT. 2 3/16" INT. 3/4" ALT. 2 15/32"

EPO-098A

OEM:K066-229

GAFF:11537



SOPORTE DELANTERO P/MOTOR
OD: 3 5/8" ID: 13/16" LG: 2 1/2" OD<: 2 1/32"

FYD-098AN

OEM:K066-229

GAFF:11537



SOPORTE DELANTERO P/MOTOR
OD: 3 3/4" ID: 3/4" LG: 2 1/2" OD<: 2 1/32"

EPO-098AH

OEM:K066-229
GAFF:11537



SOPORTE DELANTERO P/MOTOR
OD: 3 5/8" ID: 13/16" LG: 2 1/2" OD<: 2 1/32"

FYD-098AHN

OEM:K066-229
GAFF:11537



SOPORTE DELANTERO P/MOTOR
OD: 3 3/4" ID: 3/4" LG: 2 1/2" OD<: 2 1/32"

EPO-103

OEM:3515345C1
GAFF:34515



SOPORTE P/ CABINA KENWORTH, INTERNATIONAL TRUCK
EXT. 3 3/8" INT. 25/32" ALT. 3" HO. 17/32

FYD-103N

OEM:3515345C1
GAFF:34515



SOPORTE P/ CABINA KENWORTH, INTERNATIONAL TRUCK
EXT. 3 3/8" INT. 25/32" ALT. 3" HO. 17/32

EPO-114

OEM:K066-377
GAFF:11540



SOPORTE TRASERO INFERIOR P/MOTOR KENWORTH T-600
LG. 7 13/16" ANCHO. 3 1/8

FYD-114N

OEM:K066-377
GAFF:11540



SOPORTE TRASERO INFERIOR P/MOTOR KENWORTH T-600
LG. 7 13/16" ANCHO. 3 1/8

EPO-115

OEM:K066-421
GAFF:11541



SOPORTE TRASERO SUPERIOR P/MOTOR KENWORTH T-600
LG. 4 1/4" ANCHO 2 3/4"

FYD-115N

OEM:K066-421
GAFF:11541



SOPORTE TRASERO SUPERIOR P/MOTOR KENWORTH T-600
LG. 4 1/4" ANCHO 2 3/4"

EPO-135H

OEM:K266-247
GAFF:11538



SOPORTE TRASERO P/MOTOR KENWORTH T-600, T-800
ANCHO. 2" BARR. 5/8" LG. 5 5/8"

FYD-135HN

OEM:K266-247
GAFF:11538



SOPORTE TRASERO P/MOTOR KENWORTH T-600, T-800
ANCHO. 2" BARR. 5/8" LG. 5 5/8"

EPO-152
 OEM:K266177
 GAFF:11530



SOPORTE TRASERO P/MOTOR KENWORTH
 EXT. 2 19/32" EXT.< 1 1/2" INT. 5/8" ALT. 2 1/8"

EPO-152H
 OEM:K266177
 GAFF:11530



SOPORTE TRASERO P/MOTOR KENWORTH
 EXT. 2 19/32" EXT.< 1 1/2" INT. 5/8" ALT. 2 1/8"

FYD-152HN
 OEM:K266177
 GAFF:11530



SOPORTE TRASERO P/MOTOR KENWORTH
 EXT. 2 9/16" EXT.< 1 1/2" INT. 5/8" ALT. 2 1/8"

EPO-159
 OEM:K066-176
 GAFF:11705



SOPORTE PARA CABINA KENWORTH. T-800
 EXT. 2 15/16" EXT.< 1 27/32" INT. 5/8" ALT. 2 7/16"

EPO-159H
 OEM:K066-176
 GAFF:11705



SOPORTE PARA CABINA KENWORTH. T-800
 EXT. 2 15/16" EXT.< 1 27/32" INT. 5/8" ALT. 2 7/16"

FYD-159HN
 OEM:K066-176
 GAFF:11705



SOPORTE PARA CABINA KENWORTH. T-800
 EXT. 2 15/16" EXT.< 1 27/32" INT. 5/8" ALT. 2 7/16"

EPO-164
 OEM:K264-84
 GAFF:11549



SOPORTE DE RADIADOR
 OD: 1 9/16" ID: 5/8" LG: 27/32" OD<: 27/32"

EPO-164A
 OEM:K264-84
 GAFF:18978



SOPORTE DE RADIADOR
 OD: 1 9/16" ID: 1/2" LG: 27/32" OD<: 27/32"

EPO-166H
 OEM:CBA/24-650-17
 GAFF:11016/11054



SOPORTE PARA MOTOR FREIGHTLINER,
 EXT. 2 5/8" EXT.< 1 3/8" INT. 5/8" ALT. 2 1/16"

FYD-166HN
 OEM:CBA/24-650-17
 GAFF:11016/11054



SOPORTE PARA MOTOR FREIGHTLINER, EXT. 2 5/8"
 EXT.< 1 3/8" INT. 5/8" ALT. 2 1/16"



EPO-113

OEM:K066-232

GAFF:11501



BUJE CENTRAL P/SUSPENSION KENWORTH BIG SIX T-800
EXT. 5" INT. 4" LG. 4 5/8"

EPO-170

OEM:K066-058

GAFF:11502



BUJE P/ BARRA ESTABILIZADORA SUSPENSION KENWORTH
EXT. 2 7/8" INT. 2" LG. 4"

EPO-170A



BUJE P/BARRA ESTABILIZADORA
SUSPENSION KENWORTH
EXT. 3" INT. 1 7/8" LG. 4"

EPO-206

OEM:K066-449

GAFF:11719



BUJE P/ BARRA ESTABILIZADORA SUSPENSION DE AIRE
EXT. 2 7/8" INT. 1 15/16" LG. 4"

EPO-172

GAFF:11551

STAR:6072



SOPORTE PARA CABINA KENWORTH
EXT. 2 7/8" INT. 5/8" ESP. 1"

EPO-178A

OEM:373023403

GAFF:30507



BUJE P/AMORTIGUADOR KW
EXT. 1 15/16" ALT. 1" INT. 1"

FYD-180N

OEM:K066-266

GAFF:11550



GOMA P/AMORTIGUADOR DE SUSP. DE AIRE KENWORTH
EXT. 2" INT. 5/8" ALT. 1"

EPO-180

OEM:K066-266

GAFF:11550



GOMA P/AMORTIGUADOR DE SUSP. DE AIRE KENWORTH
EXT. 2" INT. 5/8" ALT. 1"

EPO-194

GAFF:18100



GOMA P/AMORTIGUADOR T/YOYO T800
EXT. 1 9/16" INT. 3/4" LG. 1 3/4"

EPO-1525

GAFF:18100



SOPORTE PARA CABINA KENWORTH
OD: 2 7/8" OD<: 1 1/2" ID: 5/8" LG: 1 1/4"

EPO-199

OEM:K17686344

GAFF:11545



GUIA P/COFRE KW-900, T-800, MACK
EXT. 3 1/4" EXT.<1 17/32"

FYD-199N

OEM:K17686344

GAFF:11545



GUIA P/COFRE KW-900, T-800, MACK
EXT. 3 1/4" EXT.<1 17/32"

EPO-218

OEM:K066-450

GAFF:11720



BUJE P/ SUSPENSION KENWORTH
EXT. 3 1/16" INT. 2 9/64" LG. 2 13/16"

EPO-223

GAFF:11566



CONTRA TACON P/CABINA Y CAMAROTE KW-T800
EXT. 2 7/8" INT< 1 13/16 INT. 5/8" ESP. 7/8"

EPO-244

OEM:63274

GAFF:11611



BUJE P/PALANCA DE VELOCIDADES FULLER
EXT. 1 33/64" INT. 53/64" ALT. 2 3/8"

EPO-245KIT

OEM:

GAFF:11566



JGO. SOPORTE P/CABINA Y CAMAROTE KW-T800
EXT. 2 7/8" INT< 1 13/16 INT. 5/8" ESP. 2"

EPO-246

GAFF:11548



SOPORTE P/RADIADOR KENWORTH
EXT. 1 21/32" INT. 17/32" LG. 1 3/8"

FYD-273N



TAPON P/BALLONETA DE ACEITE FREIGHTLINER/
KENWORTH EXT. 1" ALT. 13/16"

EPO-296



TACON P/CABINA KENWORTH
EXT. 3" EXT. < 1 1/2" INT. 5/8" ALT. 2 3/16"

EPO-296H



TACON P/CABINA KENWORTH
EXT. 3" EXT. < 1 1/2" INT. 5/8" ALT. 2 3/16"

FYD-371

OEM:K350-1887

GAFF:11547



BASE P/GUIA DE COFRE KENWORTH T-600, T-800
 LG. 8 5/8 ANCHO 3" ESP. 3/8"

FYD-372

BASE GUIA COFRE KENWORTH KW-900
 ESP. 3/8" ANCH 3 3/8" LG. 6 1/4"

EPO-507

EMPAQUE P/ COFRE KW DINA
 LG. 1 7/8" ALT. 7/8" INT. 1/2"

EPO-11620K

DAI:9025

OEM:K066-177

GAFF: 11612



SOPORTE PAR CABINA KENWORTH
 EXT. 2 19/32" EXT.< 1 9/16" INT. 5/8" ALT. 2 1/16"

FYD-465HN

OEM:K066-336

GAFF:11533



SOPORTE P/ CABINA KENWORTH
 EXT. 3" EXT.< 1 13/16" INT. 5/8" LG. 1 15/16"

EPO-465

OEM:K066-336

GAFF:11533



SOPORTE P/ CABINA KENWORTH
 EXT. 3" EXT.< 1 13/16" INT. 5/8" LG. 1 15/16"

EPO-465H

OEM:K066-336

GAFF:11533



SOPORTE P/ CABINA KENWORTH
 EXT. 3" EXT.< 1 13/16" INT. 5/8" LG. 1 15/16"

EPO-468

OEM:267322

GAFF:18949



SOPORTE P/ CABINA KENWORTH
 LG. 6 7/32 ANCHO. 2 1/4" ALT. 3 19/32 INT. 11/16"

EPO-517H

OEM:M300-70NR

GAFF:11557



BUJE PARA BISAGRA DE COFRE
 OD: 1 3/4" OD<: 1 1/8 ID: 1/2" LG: 1 5/16" "

EPO-531H

OEM:K066-232

GAFF:11529



SOPORTE P/ CABINA KENWORTH T600/T800
 EXT. 2 7/16" EXT.<. 1 9/16" INT. 7/8" ALT. 1 7/8"

EPO-830

OEM:KW08849AC

GAFF:11743



BUJE P/BARRA ESTABILIZADORA KENWORTH
EXT. 3 1/8" INT. 2 1/4" LG. 2 7/8"

FYD-830N

OEM:KW08849AC

GAFF:11743



BUJE P/BARRA ESTABILIZADORA KENWORTH
INT. 2 1/4" LG. 2 7/8"

EPO-1016

OEM:2650911

GAFF:11742



SOPORTE DE CABINA KENWORTH
INT. 1 3/8" LG. 4 15/16"

EPO-1042

OEM:SK290595

GAFF:11604



JGO. BUJES PARA QUINTA JOST KW
EXT. 3" INT. 2" LG. 4"

EPO-1071

OEM:K0664353

GAFF:18938



SOPORTE DE CABINA KENWORTH
EXT. 3" EXT.<1 17/32 INT. 5/8" LG. 3 7/16"

EPO-101671



JUEGO DE SOPORTES PARA CABINA KENWORTH

EPO-1527

OEM:K066-177

GAFF:11527



SOPORTE PARA CABINA/PETERBILT
OD: 2 19/32" ID: 5/8" LG: 2 1/16" OD<: 1 9/16"

EPO-1531

OEM:M500,70NR

GAFF:11531



SOPORTE TRASERO P/MOTOR
EXT. 2 19/32" EXT.<1 1/2" INT. 3/4" ALT. 2 1/8"

FYD-086N



TOPE GUIA DE COFRE KW
EXT. 1 1/2" ALT. 1 1/4"

EPO-309



GUIA P/ COFRE DE TRACTO KENWORTH
EXT. 1 17/16" LG. 3" TORN. 1/2" NC.

EPO-1544H
 OEM:K066B218
 GAFF:11544



BUJE P/BISAGRA DE COFRE
 OD: 1 3/4" ID: 17/32" LG: 1 1/4" OD<: 1 1/4"

FYD-1544HN
 OEM:K066B218
 GAFF:11544



BUJE P/BISAGRA DE COFRE
 OD: 1 3/4" ID: 17/32" LG: 1 1/4" OD<: 1 1/4"

FYD-1554N
 OEM:1301633
 GAFF:11554



SOPORTE PARA RADIADOR
 OD: 1" ID: 13/32" LG: 1" OD<: 27/32"

EPO-1707
 OEM:M501/05
 GAFF:11707



SOPORTE PARA CABINA
 OD: 2 1/2" OD<: 1 19/32" ID: 5/8" LG: 2"

EPO-1709
 OEM:K066218
 GAFF:11709



BUJE PARA BISAGRA DE COFRE/ BUJE AISLADOR
 OD: 1 3/4" ID: 17/32" LG: 1 3/8" OD<: 1 5/32"

EPO-1831
 OEM:LORDJ800610
 GAFF:11831



SOPORTE PARA RADIADOR
 OD: 2 1/2" ID: 21/32" LG: 13/16" OD<: 1 19/32"

FYD-1845N
 OEM:870879
 GAFF:11848



BUJE PARA SOPORTE DE RADIADOR
 T600, T680, T800
 OD: 1 9/16" ID: 5/8" LG: 1 9/32"

EPO-2367
 OEM:1304588
 GAFF:12367



BUJE PARA BISAGRA DE COFRE KENWORTH/PETERBILT
 EXT. 1 5/16" INT. 1/2" LG. 2"

EPO-6082
 PHM:TTP6082
 OEM:L856052



SOPORTE DE COFRE PREMIER KENWORTH T680, T880
 LG. 4 3/32" ALT. 1 19/32"

FYD-7498N
 OEM:U30026TGB
 GAFF:18227



SOPORTE TRASERO P/MOTOR 660 /680 KENWORTH 2018
 LG. 9 3/16" ALT. 5 1/8"

FYD-7499N

OEM:12488TGB



SOPORTE TRASERO P/MOTOR 660 KENWORTH Y PETERBILT

EPO-9130

PHM:TTP9130

OEM: L851130



TOPE DE COFRE KENWORTH T700
EXT. 2 5/16" ALT. 3 3/8" ROSCA 7/16

EPO-9019

OEM. R626013

PHM:TTH9019



BUJE SOPORTE P/CABINA KENWORTH T800

FYD-59477N

OEM. 22-30-477



BUJE SUPERIOR P/COLISION DE FALDON KENWORTH T660

FYD-9184N

OEM:KW:9184

DAI:9184



BASE PARA PEDAL ACCELERADOR KENWORTH UNIVERSAL

FYD-11681TBG

DAI:17495



SOPORTE TRASERO P/MOTOR 660 KENWORTH 2018
ALTURA AL CENTRO 3 5/16"

FYD-11773N

OEM:L856081

GAFF:11848

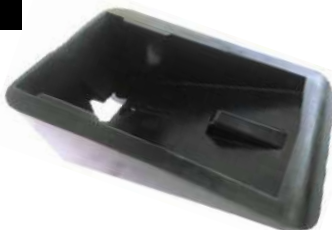

GIA DE COFRE PARA TRACTOR KW-T680 MODELO 2017-2020

FYD-12447TBG

OEM:12447TBG

GAFF:11821



SOPORTE TRASERO P/MOTOR 660 KENWORTH 2018
ALTURA AL CENTRO 3 7/8"

EPO-11819

OEM:R131014

GAFF:11819



BUJE PARA EJE DE DIRECCION, TRANSMISION KENWORTH MOD.-2013

EPO-1834

OEM:0203142400

GAFF:11834



BUJE PARA MUELLE KENWORTH MOD. T880 (2017)
EXT. 2 27/32" INT. 31/32" LG. 2 27/32"



EPO-39247L



GIA DE COFRE KENWORTH MOD.-2012

EPO-39247R



GIA DE COFRE KENWORTH MOD.-2012

EPO-4154

OEM:1304154

TTP415



KIT DE BUJES P/ COFRE DE TRACTO KENWORTH T600, T800

EPO-4154A



BUJE P/ COFRE DE TRACTO KENWORTH T600, T800

EPO-4164K

OEM:1304164

GAFF:11137

TTP417



KIT DE BUJES P/ COFRE DE TRACTO KENWORTH T600, T800

EPO-4164A

GAFF:12410



GOMA P/COFRE DE TRACTO KENWORTH T600, T800

EPO-1052



BUJE PARA MUELLE KENWORTH 29X26 EXT. 1 1/4" INT. 5/8" LG. 4 1/8"

EPO-1073

OEM:B656010

GAFF:11820



BUJE MUELLE DELANTERA KENWORTH (2012-2013) EXT. 1 3/4" INT. 5/8" LG. 4 1/4"

EPO-31009

OEM:M13-1009

GAFF:11809



BASE DE SOPORTE PARA ESCAPE KENWORTH T600/T680/T800/W900

EPO-36001

OEM:M13-6001

GAFF:11812



GOMAS P/SOPORTE PARA ESCAPE KENWORTH T600/T680/T800/W900

EPO-220



REPUESTO PARA GRANADA
EXT. 2 25/32" INT. 1 3/4" LG. 2 5/8"

EPO-097

OEM:A2297-K1052
GAFF:11512



GRANADA P/TENSOR KENWORTH BIG SIX
EXT. 4 1/8" LG. C-C- 4 3/8"

EPO-125

OEM:44695000L
GAFF:13520/
83520



GRANADA P/ TENSOR KENWORTH.
EXT.2 3/4" BARR. 13/16" C.C 4 3/8"

EPO-126

OEM:244760000
GAFF:11509/11511



GRANADA P/TENSOR HENDRICKSON KENWORTH BIG SIX
EXT. 3 1/2" BARR. 21/32" LG. C-C 4 3/8"

EPO-127

OEM:836940
GAFF:11729



GRANADA DE BOLA P/TENSOR KENWORTH AIRGLIDE,
EXT.2 3/4" HO: 11/16 LG.C-C 4 3/8"

EPO-155

OEM:44694
GAFF:83522



GRANADA BARRA DE TORSION, KW.
EXT. 2 17/32" HO 21/32 C-C 4 3/8"

EPO-157

OEM:A16-119448
GAFF:13521



GRANADA P/TENSOR KENWORTH
EXT. 2" HO. 21/32 C-C 4 13/32

EPO-157B

OEM:47691-000L
GAFF:13799



GRANADA P/TENSOR HENDRICKSON
EXT. 1 31/32" HO. 11/16 C-C 4 3/8"

EPO-157C



GRANADA P/TENSOR C/CEJAS KENWORTH
EXT. 2" LG.C-C 4 3/8"

EPO-168

OEM:K066342
GAFF:11507



GRANADA P/BARRA DE TORSION KW-T800
EXT. 2 11/16" HO. 21/32 C-C 4 3/8"

EPO-176A

OEM:6813250150

DAI:9188



NUCLEO P/TENSOR HENDRICKSON, KENWORTH
EXT. 2 3/8" LG.C-C 4 3/8"

EPO-1856

OEM:A-2297-K-1051

GAFF:11856



GRANADA P/SUSPENSION KENWORTH
OD: 4 1/8" HO: 7/8" C-C: 5 1/4"

EPO-208CM

OEM:229610

GAFF:13518



GRANADA T/BOTELLA KENWORTH,
EXT. 2 3/4" ROSCA 1 1/4" LG. 8 1/16"

EPO-195

OEM:B651006

GAFF:11753



PERNO MUELLE FRONTAL KENWORTH
EXT. 1 3/4" EXT.< 1 1/16"
C.C. 6 5/16" LG. 7 1/2"

EPO-257

OEM:52375

GAFF:11767



PERNO MUELLE FRONTAL KENWORTH
EXT. 1 3/4" EXT.< 1 1/16"
C.C. 5 7/16" LG. 6 5/8"

EPO-257A

OEM:B651005

GAFF:11758



PERNO P/ MUELLE FRONTAL KW.
EXT. 1 3/4" EXT.< 1 1/16"
C-C. 5 3/4" LG.. 7"

EPO-463

OEM:B651007

GAFF:11763



PERNO MUELLE DELANTERA KENWORTH
EXT. 2 5/64" EXT.< 1 1/16"
C.C. 6 5/16 LG. 7 1/2 "

EPO-1775

OEM:8656005

GAFF:11775



PERNO MUELLE DELANT. KENWORTH
EXT. 2 1/8" EXT.< 1"
C.C. 5 15/32" LG. 6 3/4"

EPO-881

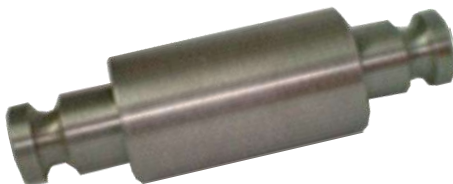

PERNO MUELLE DELANT. KENWORTH
EXT. 2 5/64" EXT.<. 1 1/16"
C. C. 5 3/8" LG. 6 5/8"

EPO-1846

OEM:B656005

GAFF:11846



PERNO MUELLE DELANT. KENWORTH
EXT. 2 3/32" EXT.< 1 1/16
C.C. 5 25/32" LG. 7"

EPO-152H
 OEM:K066177
 GAFF:11530



SOPORTE TRASERO P/MOTOR KENWORTH
 EXT. 2 19/32" EXT.< 1 1/2" INT. 5/8" ALT. 2 1/8"

FYD-152HN
 OEM:K066177
 GAFF:11530



SOPORTE TRASERO P/MOTOR KENWORTH
 EXT. 2 9/16" EXT.< 1 1/2" INT. 5/8" ALT. 2 1/8"

EPO-166
 OEM:CBA/2465017
 GAFF:11016/11054



SOPORTE PARA MOTOR FREIGHTLINER,
 EXT. 2 5/8" EXT.< 1 3/8" INT. 5/8" ALT. 2 1/16"

FYD-166HN
 OEM:CBA/2465017
 GAFF:11016/11054



SOPORTE PARA MOTOR FREIGHTLINER,
 EXT. 2 5/8" EXT.< 1 3/8" INT. 5/8" ALT. 2 1/16"

EPO-183
 OEM:0516070000
 GAFF:11021



SOPORTE PARA RADIADOR FREIGHTLINER
 EXT. 2 31/32" EXT.< 1 1/2" INT. 9/16"

EPO-305K
 OEM:J20120
 GAFF:11113



SOPORTE P/MOTOR FREIGHTLINER M2-106 SERIE 60,70, 80.
 EXT. 3 7/8" INT. 25/32" ALT. 3"

EPO-305
 OEM:J20120
 GAFF:11095



SOPORTE PARA MOTOR FREIGHTLINER
 OD: 3 3/4" ID: 25/32" LG: 2 11/16"

EPO-305C
 OEM:J20120
 GAFF:11112



EPO-174
 OEM:LORSSB3310017
 GAFF:11093



SOPORTE INFERIOR P/CABINA FREIGHTLINER
 EXT. 3 25/32" EXT.< 2 17/32" INT. 3/4" ALT. 2 9/16"

FYD-174N
 OEM:LORSSB3310017
 GAFF:11093



SOPORTE INFERIOR P/CABINA FREIGHTLINER
 EXT. 3 25/32" EXT.< 2 17/32" INT. 3/4" ALT. 2 9/16"

EPO-069H

OEM:J7165-1
GAFF:11522



SOPORTE P/RADIADOR FREIGHTLINER
EXT. 2 7/8" EXT< 1 13/16 INT.5/8" ALT. 1 1/4"

EPO-1172

OEM:J621046
GAFF:11172



SOPORTE P/CABINA FREIGHTLINER 2008
OD: 3" ID: 5/8" LG: 1 13/16" OD<: 2"

EPO-307

OEM:BJ1769
GAFF:11075



SOPORTE P/CABINA FREIGHTLINER
EXT. 3 25/32" INT. 21/32" LG.3 1/8"

EPO-1131

GAFF:11131



SOP. P/CABINA FREIGHTLINER CENTURY 112, 120, COLUMBIA (2007- 2008)
INT. 21/32" LG. 3 1/2"

EPO-1082

OEM:M203075
GAFF:12408



GOMA PARA POST ENFRIADOR FREIGHTLINER
EXT. 1 1/8 EXT.< 25/32" INT. 3/8" ALT. 1"

EPO-1084

OEM:A171366600
GAFF:11124



SOPORTE PARA COFRE FREIGHTLINER COLUMBIA 2008
LG. 3 7/16" ALT. 2 1/4" LGC-C.15/8"

EPO-1114

GAFF:11114



SOPORTE PARA CABINA FREIGHTLINER
ID: 9/16" LG: 4 3/32" H: 1 25/32" HO: 5/16" C-C : 1 11/16"

EPO-213

OEM:0115047000
GAFF:11018



SOPORTE DELANTERO P/MOTOR FREIGHTLINER
EXT. 3 1/4" INT. 3/4" LG. 2 1/4"

EPO-1129

OEM:BCD288471
GAFF:11129



SOPORTE PARA RADIADOR FREIGHTLINER
LG: 4" WD: 3 7/8" H: 1 1/4" 1/2-13 UNC

EPO-1145

OEM:A1715140000
GAFF:11145



SOPORTE P/COFRE FREIGHTLINER
LG: 3 7/16" WD: 1 13/16" H: 4" LG C-C: 1 11/16"

EPO-217

OEM:1610549000
GAFF:11064/11000



BUJE BALANCIN FREIGHTLINER FH-34 A
EXT. 3 25/32" EXT.< 2 3/4" INT. 2 9/32" ALT. 2 1/4"

EPO-226

OEM:A1710464001
GAFF:11020



GUIA PARA COFRE FREIGHTLINER
OD: 4" ID: 1/2" LG: 3" OD<: 1 7/8"

EPO-306

OEM:BCD288051
GAFF:11077



KIT DE SOPORTE TRASERO P/MOTOR FREIGHTLINER
LG. 9 7/8" ALT. 3" HO. 9/16

FYD-306N

OEM:BCD288051
GAFF:11077



KIT DE SOPORTE TRASERO P/MOTOR FREIGHTLINER
LG. 9 7/8" ALT. 3" HO. 9/16

EPO-133

OEM:J209413
GAFF:11065



SOPORTE P/MOTOR FREIGHTLINER
ID: 21/32" LG: 5 13/32" WD: 2 3/8" H: 3"

EPO-288

OEM:BCD267511
GAFF:11073



SOPORTE DELANTERO P/MOTOR FREIGHTLINER
LG. 7 1/4" ANCHO 3 1/4" INT. 3/4" C.C. 4"

EPO-289

OEM:BCD267041
GAFF:11072



SOPORTE TRASERO P/MOTOR FREIGHTLINER
LG. 6 9/16" ANCHO 2 9/16" INT. 25/32" C.C. 4"

FYD-368N

OEM:A1615773000
GAFF:31624



SOPORTE P/SUSPENSION DELANTERA FREIGHTLINER
ALT. 3" ANCHO 2 7/8" LG. 4 3/8"

EPO-11074

GAFF:11074



KIT SOPORTE TRASERO P/MOTOR FREIGHTLINER
LG. 6 9/16" ANCHO 2 9/16" INT. 25/32" C.C. 4"

FYD-20868N

OEM:A1720868-000
GAFF:11177



GUIA PARA COFRE FREIGHTLINER CASCADIA

EPO-21113
 OEM: J-21113
 GAFF: 11137
 TTP1005



SOPORTE PARA MOTOR FREIGHTLINER
 EXT. 2 5/8" HO 7/8" LG. 2 15/16"

FYD-21247N
 OEM: J-21247-4
 GAFF: 11116



SOPORTE PARA MOTOR FREIGHTLINER MOD. CASCADIA

EPO-239
 OEM: J177005
 GAFF: 11019



BUJE P/ BISAGRA DE COFRE FREIGHTLINER
 EXT. 1 3/8" INT. 1/2" ALT. 2 3/16"

EPO-1066
 OEM: LORSM10359
 GAFF: 11117



SOPORTE DE RADIADOR FREIGHTLINER
 LG. 4" ANCHO: 1 3/4 ALT. 1 5/8" R: 3/8" NC. CC. 2 11/32

EPO-1067
 GAFF: 11108



SOPORTE PARA CABINA CENTURY 2007 FREIGHTLINER
 ALT. 3 5/16" LARGO. 6 9/16"

EPO-1144
 OEM: A6805040382
 GAFF: 11144



SOPORTE P/ RADIADOR
 LG: 4" WD: 1 13/16" H: 2 3/32" R: 3/8- NC CC: 2 11/32"

FYD-1096N
 OEM: 1712434000
 GAFF: 11096



GANCHO PARA COFRE FREIGHTLINER FLD CLASIC
 (2003-2008)

FYD-1098N
 GAFF: 11098



BASE PARA GANCHO DE COFRE FREIGHTLINER M-2
 AÑO 2008

FYD-273N
 GAFF: 18044



TAPON P/BALLONETA DE ACEITE FREIGHTLINER
 EXT. 1 9/32" EXT. < 1" INT. 3/8" ALT. 13/16"

FYD-11070N
 GAFF: 11070

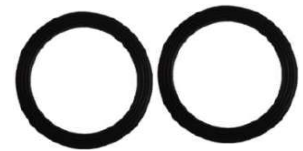

EMPAQUE PARA TAPON DE TANQUE DIESEL
 OD: 3 11/32" ID: 2 7/16" TK: 3/16"

FYD-111490N

OEM:LORJ2618528

GAFF:11149

SOPORTE TRAS. P/MOTOR FREHIGTLINER – CASCADIA 2008

FYD-111790N

OEM:0134070000

GAFF:11179

SOP. TRASERO P/MOTOR FREHIGTLINER – CASCADIA 2017

EPO-1065

OEM:1615641000

GAFF:11130

 COJIN DE DESJASTE PARA PERCHA FREIGHTLINER 06-09
 LG: 7" ANCHO 3" ALT. 2 5/16"

EPO-111280

OEM:1847463000

GAFF:11128

 SOPORTE P/CABINA FREIGHTLINER MOD. COLUMBIA /M2
 OD: 2 27/32" ID: 5/8" LG: 3 1/2"

EPO-1064

OEM:1859922000

GAFF:11127

 SOPORTE PARA CABINA FREIGHTLINER CASCADIA
 EXT. 80mm EXT.> 67.2 mm EXT<65 mm INT. 5/8"

FYD-1178N

OEM:1859922000

GAFF:11178

 SOPORTE PARA CABINA FREIGHTLINER CASCADIA
 LG. 6 9/32" ANC.3 1/2" ALT. 4 1/4" HO. 5/8" CC. 4 17/32"

EPO-8994

OEM:58918000

GAFF:18994

 SOP.TRAS. P/ MUELLE FREIGHTLINER AIRTEX/CASCADIA
 ALT. 6" INT. 13/16 ESP.2"

EPO-1126

OEM:593461

GAFF:11126

 TAPAS PARA SOPORTE DE MUELLE FREIGHTLINER
 COLUMBIA/CASCADIA

EPO-882

GAFF:34532

 BUJE P/TENSOR DE CABINA INTERNATIONAL
 EXT. 1 3/16" INT. 1/2" LARGO 2 1/16"

EPO-1059

OEM:59259002

GAFF:11123

 BUJE MUELLE DELANT. FREIGHTLINER COLUMBIA FLC. (08)
 EXT. 1 31/32" INT. 13/16" LG. 3 7/32"

FYD-937N
STAR:6118



GANCHO CHICO P/COFRE KENWORTH,
FREIGHTLINER 22 CM

FYD-938N
STAR:6146



GANCHO MEDIANO P/COFRE
KENWORTH, FREIGHTLINER 24 CM

FYD-939N
STAR:6120



GANCHO LARGO P/COFRE KENWORTH,
FREIGHTLINER 28 CM

FYD-940N
STAR:6148



GANCHO EXTRALARGO P/COFRE
KENWORTH, FREIGHTLINER 33 CM

EPO-1132
GAFF:11132



BUJE P/BARRA DE TORSION DE CABINA FREIGHTLINER
COLUMBIA 2008
EXT. 1 7/16" BARR. 5/8" LG.1 1/32"

EPO-012
OEM:TRB5560



BUJE P/ TENSOR DE CAMAROTE FREIGHTLINER
EXT. 1 1/8" INT. 1/2" LG. 2"

EPO-216



BUJE P/TENSOR DE CAMAROTE FREIGHTLINER
EXT. 1 3/8" INT. 5/8" LG. 2"

EPO-1133
GAFF:11133



BUJE P/MUELLE DELANTERA FREIGHTLINER
OD: 2 1/16" ID: 13/16" LG: 3 1/4"

EPO-081
OEM:6803220150
GAFF:11066



BUJE P/ MUELLE FREIGHTLINER CENTURY/CASCADIA.
EXT. 2 1/4" INT. 3/4" LG. 4 1/4"

FYD-081N
OEM:6803220150
GAFF:11066



BUJE P/ MUELLE FREIGHTLINER CENTURY/CASCADIA.
EXT. 2 1/4" INT. 3/4" LG. 4 1/4"

EPO-1142

OEM:161647300
GAFF:11142



BUJE P/MUELLE FREIGHTLINER M2 2008
OD: 1 3/4" ID: 3/4" LG: 3 9/16"

EPO-11900



BUJE P/MUELLE FREIGHTLINER CASCADIA DELANTERO 2021
EXT. 60 mm INT. 24 mm LG. 109 mm

FYD-162050N

OEM:1620508000
RB374



BUJE P/MUELLE FREIGHTLINER CASCADIA DELANTERO 2021
EXT. 60 mm INT. 20 mm LG. 108 mm

EPO-155

OEM:51087148
GAFF:13522



GRANADA BARRA DE TORSION, KW.
EXT. 2 17/32" HO 21/32 C-C 4 3/8"

EPO-157

OEM:A16119448
GAFF:13521



GRANADA P/TENSOR FREIGHTLINER
EXT. 2" HO. 21/32 C-C 4 13/32

EPO-214

OEM:1613962000
GAFF:11005



GRANADA P/SUSPENSION FREIGHTLINER, T/LARGA
EXT. 2 1/2" C-C. 5 3/4" HO. 13/16"

FYD-214AN

OEM:1616412000
GAFF:11083



GRANADA P/SUSPENSION FREIGHTLINER, FAS II AIRLINER/FL
EXT. 2 1/2" C-C. 5 11/16" HO. 13/16"

EPO-341

OEM:47691
GAFF:11004



GRANADA P/SUSPENSION FREIGHTLINER
EXT. 2" HO 11/16" C.C 4 13/32"

EPO-809

GAFF:11006





GRANADA P/TENSOR FREIGHTLINER
EXT. 2 5/16"



EPO-1162



OEM:80480078000
GAFF:11162



GRANADA P/SUSP. FREIGHTLINER
EXT. 3 15/16" HO 29/32" C.C 6 7/8"

<p>EPO-1163</p> <p>OEM:62480041000</p> <p>GAFF:11163</p>  <p style="text-align: center;">GRANADA P/SUSP. FREIGHTLINER EXT. 2 15/16" HO 11/16" C.C 4 3/8"</p>	<p>EPO-1166</p> <p>GAFF:11166</p>  <p style="text-align: center;">GRANADA P/SUSPENSION FREIGHTLINER OD: 3 11/32" HO: 29/32" LG C-C: 6 7/8"</p>
---	--

<p>EPO-40263</p> <p>OEM:55480040</p> <p>GAFF:40263</p>  <p style="text-align: center;">GRANADA P/SUSPENSION FREIGHTLINER OD: 2 15/16" HO: 13/16" LG C-C: 4 3/8"</p>	<p>FYD-193</p> <p>OEM:HRI-HBU541</p> <p>GAFF:11063</p>  <p style="text-align: center;">PERNO P/BARRA DE TORSION FREIGHTLINER EXT. 1 3/4" BARR. 21/32" C-C 5 3/8" LG.7"</p>
--	--

<p>EPO-490</p> <p>OEM:1614603000</p> <p>GAFF:11094</p>  <p style="text-align: center;">PERNO P/MUELLE FREIGHTLINER EXT. 2 1/4" EXT.< 1 1/4" LG.C-C. 5 3/8" LG. 6 3/4"</p>	<p>EPO-1060</p> <p>GAFF:11060</p>  <p style="text-align: center;">PERNO DELANTERO PARA MUELLE FREIGHTLINER FL OD: 1 25/32" OD<: 1" LG C-C: 5 3/4" LG. 7"</p>
--	--



EPO-108

OEM:470031C2

GAFF:10504



SOP. DELANTERO MOTOR INTERNATIONAL TRUCK
EXT. 2 3/4" EXT.< 1 5/8" INT. 5/8" ALT.2 9/16"

EPO-108H

OEM:470031C2

GAFF:10504



SOP. DELANTERO MOTOR INTERNATIONAL TRUCK
EXT. 2 3/4" EXT.< 1 5/8" INT. 5/8" ALT.2 9/16"

EPO-109

OEM:470031C2

GAFF:10502



SOP. TRASERO P/MOTOR INTERNATIONAL TRUCK
EXT. 2 3/8" EXT.< 1 1/2" INT. 5/8" ALT. 2 3/8"

EPO-109H

OEM:470031C2

GAFF:10502



SOP. TRASERO P/MOTOR INTERNATIONAL TRUCK
EXT. 2 3/8" EXT.< 1 1/2" INT. 5/8" ALT. 2 3/8"

EPO-164A

OEM:270203C1IR30

GAFF:18063



SOPORTE P/RADIADOR INTERNATIONAL TRUCK
EXT. 1 19/32" EXT.< 13/16 INT. 1/2" ESP. 13/16"

EPO-1536

OEM:127426

GAFF:11536



SOPORTE P/SUSPENSION DE AIRE WCTA-2590-HD
OD: 3 11/16" OD:< 2 1/4" ID: 27/32" LG: 2 1/2"

EPO-265

OEM:449713-C2

GAFF:10004



SOPORTE P/CABINA INTERNATIONAL TRUCK
LG. 3 1/2" ANCHO 3" INT. 3/4" ALT.1 15/16"

EPO-093

GAFF:10026



GUIA P/ COFRE INTERNATIONAL TRUCK
EXT.2 1/4" ALT.2" TORN. 3/8"NC

EPO-329

OEM:571960C1

GAFF:30544

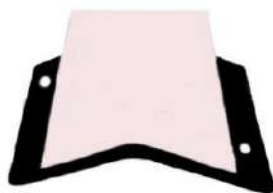

SOPORTE P/MUELLE "Z" INTERNATIONAL TRUCK
ALT.2 1/16" LG. 5 9/16"

EPO-329A

OEM:571960C1

GAFF:30544



SOPORTE P/MUELLE "Z" INTERNATIONAL TRUCK
ALT.2 1/16" LG. 5 9/16"



FYD-094N

OEM:3554205C2



SOP. P/PERCHA SOBRE CARGA INTERNATIONAL S4000
MOD. 05 LG.5 1/4" ALT. 4 3/8"

FYD-526N

OEM:34591Q69C2



SOP. P/MOTOR HEAVY DUTY INTERNATIONAL 04-08 S 7600

EPO-1079

OEM:3549169C2

GAFF:34529



SOPORTE TRASERO PARA MOTOR INTERNACIONAL
TRUCK LG. 5" WD. 3" ALT. 3 13/16" INT. 11/16"

FYD-927N



SOPORTE MOTOR IZQ. Y DER. INTERNATIONAL

EPO-184

OEM:472697C1

GAFF:34536



TOPE P/MUELLE O GUIA DE FAMSA
EXT. 2 7/16" ALT.1 3/4" TORN. 5/16 NC.

FYD-184N

OEM:472697C1

GAFF:34536



TOPE P/MUELLE O GUIA DE FAMSA
EXT. 2 7/16" ALT.1 3/4" TORN. 5/16 NC.

EPO-4545

OEM:3560217C3

GAFF:34545



SOPORTE P/RADIADOR INTERNATIONAL TRUCK
OD: 2 3/16" ID: 17/32" LG: 1 1/8" OD<: 1 7/32"

EPO-1069

OEM:3887225C1

GAFF:34589



SOPORTE P/BISAGRA DE COFRE INTERNATIONAL TRUCK
EXT. 2 1/16" INT.3/8" WD. 1 25/32" LG. 2 1/16"

FYD-6076N

STAR:6075

GAFF:11522



GOMA CASETA CUMMINS, DINA
EXT. 3" INT. 5/8" ALT. 1 3/16"

EPO-202

OEM:90008149

GAFF:14528



BUJE LATERAL P/SUSP. INTERNATIONAL TRUCK/NEWAY
EXT. 2 13/16" INT. 1 1/8" LG. 5"



EPO-103

OEM:3515345C1

GAFF:34515



SOPORTE P/ CABINA KENWORTH, INTERNATIONAL TRUCK
EXT. 3 3/8" INT. 25/32" ALT. 3" HO. 17/32

FYD-103N

OEM:3515345C1

GAFF:34515



SOPORTE P/ CABINA KENWORTH, INTERNATIONAL TRUCK
EXT. 3 3/8" INT. 25/32" ALT. 3" HO. 17/32

EPO-103A

OEM:3512064C4

GAFF:34528



SOPORTE P/ CABINA INTERNATIONAL TRUCK
EXT. 3 3/8" INT. 1/2" ALT. 3" HO. 17/32

EPO-505



SOPORTE P/ CABINA INTERNATIONAL
EXT. 3 3/8" INT. 5/8" ALT. 3" CC. 5"

EPO-177

OEM:1664728C2

GAFF:34500



SOPORTE SUPERIOR TRASERO DINA INTERNATIONAL
LG. 5 3/8" ANCHO 3 1/8" INT. 11/16" HO 3/8 NC

FYD-177N

OEM:1664728C2

GAFF:34500



SOPORTE SUPERIOR TRASERO DINA INTERNATIONAL
LG. 5 3/8" ANCHO 3 1/8" INT. 11/16" HO 3/8 NC

EPO-431

OEM:1664723C1

GAFF:34509



SOPORTE SUPERIOR TRASERO DINA INTERNATIONAL
LG. 5 3/8" ANCHO 3 1/8" INT. 11/16" HO 3/8 NC

FYD-431N

OEM:1664723C1

GAFF:34509



KIT SOP. DELANTERO P/MOTOR
INTERNATIONAL INT. 11/16"

EPO-518

OEM:1664728C1

GAFF:34510



SOP. P/MOTOR INTERNATIONAL POLIURETANO
LG. 7" WD. 3 3/8" ALT. 4 3/4" INT. 13/16"

FYD-518N

OEM:1664728C1

GAFF:34510



SOP. TRASERO P/MOTOR INTERNATIONAL HULE NEGRO
LG. 7" WD. 3 3/8" ALT. 4 3/4" INT. 13/16"



EPO-500
 OEM:1664726C2
 GAFF:34507



CONTRA SOPORTE INFERIOR P/MOTOR INTERNATIONAL
 EXT. 3" INT. 21/32 ALT. 9/16"

FYD-500N
 OEM:1664726C2
 GAFF:34507



CONTRA SOPORTE INFERIOR P/MOTOR INTERNATIONAL
 EXT. 3" INT. 21/32 ALT. 9/16"

EPO-518A
 OEM:1664726C2
 GAFF:34522



CONTRA SOPORTE TRASERO MOTOR INTERNATIONAL
 EXT. 3" INT. 25/32" ALT. 15/16"

FYD-518AN
 OEM:1664726C2
 GAFF:34522



CONTRA SOPORTE TRASERO MOTOR INTERNATIONAL
 EXT. 3" INT. 25/32" ALT. 15/16"

EPO-10028
 OEM:497501C2
 GAFF:10028



BUJE P/BALANCIN INTERNATIONAL TRUCK, NAVISTAR
 CORPORATE AIR.
 EXT. 2 5/8" INT. 1" LG. 4 1/3"

EPO-882
 GAFF:34532



BUJE P/TENSOR DE CABINA INTERNATIONAL
 EXT. 1 3/16" INT. 1/2" LARGO 2 1/16"

EPO-4581
 OEM:3810979C4
 GAFF:34581



SOPORTE DERECHO PARA COFRE INTERNATIONAL TRUCK
 LG: 8 3/16" WD: 6 15/32" H: 213/32" HO: 29/64" TK: 5/16"

EPO-4583
 OEM:3810978C4
 GAFF:34583



SOPORTE IZQUIERDO PARA COFRE INTERNATIONAL TRUCK
 LG: 8 3/16" WD: 6 15/32" H: 213/32" HO: 29/64" TK: 5/16"

EPO-39027-L
 OEM:3559239C2



GUIA DE COFRE INTERNATIONAL 9400 (IZQUIERDO)

EPO-39027-R
 OEM:3559239C2



GUIA DE COFRE INTERNATIONAL 9400 (DERECHO)



EPO-444

OEM:90005151

GAFF:14514



BUJE LATERAL MERCEDES BENZ
EXT. 3 1/2" INT. 1 1/8" LG. 5"

EPO-148

OEM:507569C91

GAFF:10023



SOPORTE TRASERO P/MOTOR INTERNATIONAL
EXT. 3 17/32 EXT. 3 1/16" INT. 1 1/2" LG. 3"

EPO-148H

OEM:507569C91

GAFF:10075



SOPORTE TRASERO P/MOTOR INTERNATIONAL
EXT. 3" INT. 1 1/2" LG. 3"

FYD-148HN

OEM:507569C91

GAFF:10075



SOPORTE TRASERO P/MOTOR INTERNATIONAL
EXT. 3" INT. 1 1/2" LG. 3"

EPO-4586

GAFF:34586



BUJE P/BARRA DE TORSION PROSTAR, INTERNATIONAL
EXT. 2 1/32" INT. 3/4" LG. 4 3/8"

EPO-1089

OEM:1668950C1

GAFF:34530



BUJE PARA BISAGRA DE COFRE INTERNATIONAL TRUCK
EXT. 1 1/2" INT. 13/32" LG. 2 5/32"

EPO-276

OEM:3574680C1

GAFF:34516



SOPORTE P/CABINA INTERNATIONAL PRO STAR
EXT. 2 7/8" INT. 1/2" ALT. 3 1/4"

FYD-276N

OEM:3574680C1

GAFF:34516



SOP. P/CABINA INTERNATIONAL (2007)
EXT. 2 7/8" INT. 1/2" ALT. 3 1/4"

EPO-276A

OEM:3574680C1

GAFF:34552



SOP. P/CABINA INTERNATIONAL PRO STAR (07)
EXT. 2 7/8" INT. 5/8" ALT. 3 1/4"

FYD-276AN

OEM:3574680C1

GAFF:34552



SOP. P/CABINA INTERNATIONAL (2007)
EXT. 2 7/8" INT. 5/8" ALT. 3 1/4"



EPO-131

GAFF:13513



BUJE P/BALANCIN HENDRICKSON, INTERNATIONAL TRUCK
 EXT. 2 1/2" INT. 1" LG. 4 23/32"

EPO-161

OEM:497501C2



BUJE P/BALANCIN INTERNATIONAL, NAVISTAR
 EXT. 2 1/2" INT. 1" LG. 4 1/2"

EPO-215

OEM:45477

GAFF:13514



BUJE P/BARRA DE TORSION, INTERNATIONAL, FAMSA 2000
 EXT. 3" INT. 1 1/8" LG. 3 1/4"

EPO-1070

GAFF:34523



BUJE MUELLE NAVISTAR 25X29 EN INTERNATIONAL (05-10)
 EXT. 1 1/2" INT. 3/4" LG. 4 1/4"

EPO-4550

OEM:3533233C1

GAFF:34550



BUJE P/BALANCIN INTERNATIONAL, TRUCK (2011)
 EXT. 2 1/2" INT. 1" LG. 4 1/4"

EPO-248

OEM:3525665C1

GAFF:34511



BUJE P/MUELLE DEL. DE INTERNATIONAL TTUCK
 EXT. 1 27/32" INT. 3/4" LG. 4 1/4"

FYD-248N

OEM:3525665C1

GAFF:34511



BUJE P/MUELLE DEL. DE INTERNATIONAL TTUCK
 EXT. 1 27/32" INT. 3/4" LG. 4 1/4"

EPO-248A



BUJE P/MUELLE DELANTERA DE INTERNATIONAL
 EXT. 1 13/16" INT. 3/4" LG. 4 1/4"

FYD-248AN



BUJE P/MUELLE DELANTERA DE INTERNATIONAL
 EXT. 1 13/16" INT. 3/4" LG. 4 1/4"



EPO-248B



BUJE P/ MUELLE DELANTERA INTERNATIONAL
EXT. 1 3/4" INT. 3/4" LG. 4 1/4"

FYD-248BN



BUJE P/ MUELLE DELANTERA INTERNATIONAL
EXT. 1 3/4" INT. 3/4" LG. 4 1/4"

EPO-248C



BUJE P/MUELLE DELANTERA DE INTERNATIONAL T/NUEVO
EXT. 1 7/8" INT. 3/4" LG. 4 1/4"

FYD-248CN



BUJE P/MUELLE DELANTERA DE INTERNATIONAL T/NUEVO
EXT. 1 7/8" INT. 3/4" LG. 4 1/4"

EPO-248D



BUJE P/MUELLE DELANTERA DE INTERNATIONAL
EXT. 1 27/32" INT. 5/8 LG. 4 1/4"

EPO-248F



BUJE P/MUELLE DELANTERA INTERNATIONAL
EXT. 1 3/4" INT. 5/8 LG. 4 1/4"

EPO-125

OEM:44695000L

GAFF:13520



GRANADA PARA TENSOR INTERNATIONAL TRUCK
EXT. 2 3/4" BARR. 21/32" C.C 4 3/8"

EPO-157

OEM:A16119448

GAFF:13521



GRANADA P/TENSOR FREIGHTLINER
EXT. 2" HO. 21/32 C-C 4 13/32

EPO-211

OEM:57256000

GAFF:11714



GRANADA P/TENSOR INTERNATIONAL TRUCK
EXT. 2 15/32" BARR. 21/32" LG.C-C 4 3/8"

EPO-522

OEM:64400004L

GAFF:34534



GRANADA T/BOTELLA P/INTERNATIONAL TRUCK 2010
EXT. 2 17/32" LG. 8 1/16"



EPO-4591
 OEM:3820005C2
 GAFF:34591



GRANADA P/SUSP. INTERNATIONAL
 EXT. 2 1/8" HO. 21/32 C.C. 5 3/4"

EPO-4592
 OEM:380006C2
 GAFF:34592



GRANADA P/SUSP. INTERNATIONAL TRUCK
 EXT. 2 1/8" HO. 21/32 C.C. 4 3/8"

EPO-146
 OEM:32174000
 GAFF:13519



GRANADA P/TENSOR T/ YOYO FAMSA
 EXT. 3 19/32" HO. 21/32 LG.C-C. 4 3/8"

EPO-208CM
 OEM:229610
 GAFF:13518



GRANADA T/BOTELLA HENDRICKSON, KENWORTH,
 EXT. 2 3/4" ROSCA 1 1/4" LG. 8 1/16"

EPO-214
 OEM:1613962000
 GAFF:11005



GRANADA FREIGHTLINER, LARGA LISA
 EXT. 2 1/2" C-C. 5 3/4" HO.13/16" LG. 7 1/2"

FYD-214A
 OEM:1616412000
 GAFF:11083



GRANADA FREIGHTLINER, LARGA ORIJNAL FAS II AIRLINER/FL
 EXT. 2 1/2" HO. 7/8" C-C. 5 21/32" LG. 7 1/2"

SOPORTES PERKINS

FYD-040N

DAI:1804

GAFF:16506



SOPORTE DEL. IZQ. Y DER. P/MOTOR PERKINS
LG. 4 5/16" ANCHO. 2 3/16"

FYD-041N

DAI:9065

GAFF:16507



SOPORTE CENTRAL P/MOTOR PERKINS
LG. 5 1/4" INT. 5/8" ANCHO. 1 21/32"

FYD-927N



SOPORTE MOTOR IZQ. Y DER. INTERNATIONAL

FYD-236N

DAI:1643-A

GAFF:16510



SOPORTE P/MOTOR PERKINS DODGE
ANCHO. 3 5/8" LG. 4 3/8"

EPO-158

DAI:9077

GAFF:17541



JGO. DE GAJOS MEDIANOS P/COMPRESOR PERKINS
ALT. 3/4" ANCHO 7/8"

EPO-158A

DAI:9036

GAFF:17508



JGO. DE GAJOS GRANDES P/COMPRESOR 2005
ALT. 1 1/4" ANCHO 15/16"

EPO-088

DAI:9051

GAFF:17511

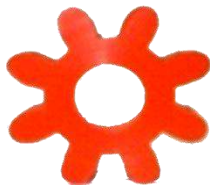

COPLÉ CHICO DE COMPRESOR PERKINS F-1
EXT. 2 13/16" INT. 15/16" ESP. 23/32"

EPO-089

DAI:9016

GAFF:17518

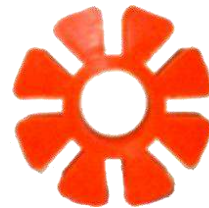

COPLÉ DE COMPRESOR MEDIANO PERKINS F-2
EXT. 3 3/8" INT. 1 1/4" ESP. 29/32"

EPO-090

DAI:9015

GAFF:17507

OEM:2581111

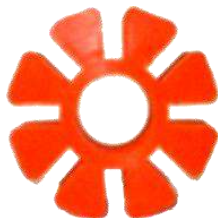

ACOPLE P/BOMBA DE INYECCION CUMMINS.
EXT. 3 3/8" INT. 1 1/4" ESP. 1 9/32"

FYD-154HN

RB-81



BUJE P/MUELLE DODGE RAM CHARGER 4X4 (1985-1996)
EXT. 1 1/4" INT. 5/8" LG. 2 7/8"

FYD-154N

RB-81

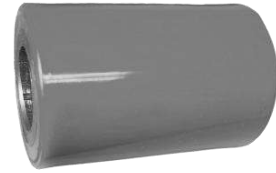

BUJE P/MUELLE DODGE RAM CHARGER 4X4, DODGE 100,
150, 250, (1985-1996) EXT. 1 5/16" INT. 5/8" LG. 2 7/8"

FYD-236N

DAI:1643-A

GAFF:16510



SOPORTE P/MOTOR PERKINS DODGE
ANCHO. 3 5/8" LG. 4 3/8"

FYD-358



SOPORTE DELANTERO P/MOTOR DODGE
ANCHO 2 1/8" LG. 4 7/16"

FYD-877R



KIT BUJES TIJERA DODGE
D-150, D-200, D-350 93

FYD-1093N

OEM: 20499003/ 4

GAFF: 31141



BUJE PARA COLUMPIO RAM 4000
EXT. 1 9/16" INT. 5/8" LG. 4"

FLOD-111



LODERA DODGE PICK UP 25 CM. X 38 CM.

FYD-663245N

OEM:7663245



BUJE P/MUELLE TRASERA DODGE RAM 700, FIAT
STRADA (2015-2020) EXT. 50.5 MM INT. 5/8"

FYD-743792N

OEM:17743792



BUJE P/MUELLE TRASERA DODGE RAM 700, FIAT
STRADA (2015-2020) EXT. 34.5 MM INT. 9/16"

EPO-267



JGO. DE SOPORTE TRASERO P/CABINA FAMSA,
INTERNATIONAL

EPO-268

OEM:3512105C2



JGO. DE SOPORTE DELANTERO P/CABINA FAMSA,
INTERNATIONAL

EPO-146

OEM:32174000

GAFF:13519



GRANADA P/TENSOR T/ YOYO **FAMSA**,
EXT. 3 19/32" HO. 21/32 LG.C-C. 4 3/8"

EPO-308

STAR:1314

OEM:SC467



SOPORTE P/MOTOR DINA 751-85
MOTOR 350 BIG CAM

EPO-351

GAFF:18533



BUJE P/AMORTIGUADOR AUTOBUS NEOPLAN
 EXT. 1 9/16" EXT.< 1 11/32 INT. 3/4" LG. 1 3/4"

FYD-493N

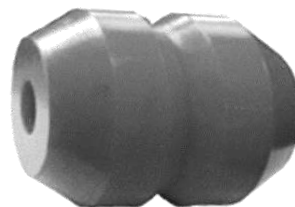

BUJE NEOPLAN FE143/130
 EXT. 5" INT. 1 1/4" LG. 5 3/8"

EPO-533



GRANADA P/BARRA DE TORSION NEOPLAN
 EXT. 2 9/16" LG/C.C. 4 7/8" BARR. 3/4"

EPO-520



BUJE P/BARRA DE TORSION NEOPLAN
 EXT. 2 1/2" INT. 1 7/16" LG. 3"

FYD-871N

GAFF:18572



TOPE P/SUSPENSION NEOPLAN
 EXT. 7 13/16" INT. 3 15/16" LG. 4 3/8"

EPO-039H

OEM:CB112110

GAFF:11544



SOPORTE BISAGRA COFRE MACK / KENWORTH
EXT. 1 3/4" EXT. < 1 1/4" INT. 17/32" ALT. 1 1/4"

EPO-197

DAI:9175

OEM:20QL1118A

GAFF:12000



SOPORTE DELANTERO P/MOTOR MACK
EXT.3 1/4" EXT.< 2" INT 3/4" ALT 1 15/32"

EPO-459

OEM:20QK324M

GAFF:12023



SOPORTE DELANTERO P/MOTOR MACK
EXT. 3 5/8" EXT.< 2 5/16" INT. 7/8" LG. 1 15/16"

EPO-112



SOPORTE P/MOTOR MACK.
EXT.3 1/2" EXT.<2 7/32" INT. 3/4" ALT. 2"

EPO-175

GAFF:18786



SOPORTE DELANTERO P/MOTOR CATERPILLAR
EXT. 3 7/16" INT. 29/32" ALT. 3"

EPO-237

OEM:20QL259A

GAFF:12032



SOPORTE P/RADIADOR MACK
EXT. 1 7/8" INT. 5/8" LG. 1 13/16"

EPO-125

OEM:44695000L

GAFF:13520



GRANADA PARA TENSOR MACK
EXT. 2 3/4" BARR. 21/32" C.C 4 3/8"

EPO-157B

OEM:SSR0035P240

GAFF:12051



GRANADA P/TENSOR MACK
EXT. 1 15/16" HO. 21/32 C-C 4 13/32"

EPO-209CM

OEM:46735

GAFF:12031



GRANADA T/BOTELLA HENDRICKSON, MACK.
EXT. 2 3/4" ROSCA. 1 1/4" LG. 7"

EPO-2043

OEM:10QK253M

GAFF:12043



BUJE P/ MUELLE MACK
OD: 1 29/32" ID: 31/32" LG: 3 13/32"

EPO-988

OEM:3405416809

GAFF:35012



GRANADA P/BARRA DE TORSION MAN BUS IRIZAR PB.
EXT. 2 9/16 HO 19/32 C.C. 3 5/32

EPO-841

OEM:1104335

GAFF:32007



GRANADA P/TENSOR MAN BUS, VOLVO BUS, SCANIA BUS
EXT. 3 5/16" HO. 3/4" LG. C.C. 5 1/8"

EPO-989

OEM:81432206177

GAFF:35013



BUJE PARA BARRA DE TORSION MAN BUS IRIZAR PB
EXT. 2 9/16 INT. 19/32 LG. 3 9/32 THR. M16X1

EPO-2056

OEM:81433150009

GAFF:32056



GRANADA P/TENSOR MAN BUS,
EXT. 3 23/32" HO. 3/4" C.C. 5 23/32"

EPO-892A

OEM:81962100450

GAFF:35002

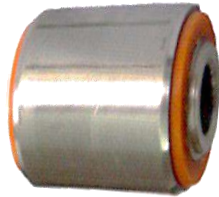

BUJE BARRA ESTABILIZADORA MAN BUS
EXT. 48.5MM INT. 16MM LG. 47MM

FYD-431N

OEM:1664723C1

GAFF:34509



KIT SOP. DELANTERO P/MOTOR MAN BUS
LG. 4 1/16" INT. 11/16" ALT. 2"

EPO-35010

GAFF:35010



SOPORTE P/REDIADOR MAN BUS
OD: 2 5/16" ID: 11/16" LG: 2 1/4" HO: 13/32" C-C: 4 1/4"

FYD-5003N



SOPORTE PARA MOTOR MAN BUS
OD: 4 5/32" ID: 27/32"

EPO-35014

OEM:81432706126

GAFF:35014



GRANADA P/TENSOR MAN BUS,
EXT. 3 5/16" HO. 3/4" C.C. 5 1/8"

EPO-198

OEM:56929000

GAFF:13550



SOPORTE PARA MUELLE HENDRICKSON
LG. 3 23/32" ANCHO. 3 1/4"

EPO-461

OEM:586480004

GAFF:18821



BUJE PIVOTE HENDIRCKSON
EXT. 3 11/16 EXT.< 3 1/8" INT. 1 1/4" LG. 3 5/8"

EPO-364

OEM:56557002

GAFF:13524



COJIN DE DESGASTE HENDRICKSON
ALT. 2 7/8" LG. 6 3/4" ANCHO. 3"

EPO-091

OEM:46736

GAFF:13516



BUJE P/SUSPENSION HENDRICKSON
EXT. 2 3/4" INT. 1 1/8" LG. 3 1/4"

EPO-107

OEM:47420

GAFF:13526



BUJE CENTRAL P/BALANCIN HENDRICKSON E-4
EXT. 2 3/4" INT. 1" LG. 4 3/8"

EPO-118

OEM:47421

GAFF:13512



BUJE LATERAL P/SUSPENSION HENDRICKSON E-4.
EXT. 2 3/8" INT. 7/8" LG. 3 1/8"

EPO-118A

OEM:47421

GAFF:13511



BUJE LATERAL P/MUELLE SUSPENSION HENDRICKSON E-4.
EXT. 2 3/8" INT. 1" LG. 3 1/8"

EPO-118C

GAFF:10000



BUJE P/BARRA TENSOR INTERNATIONAL
EXT. 2 11/32" INT. 7/8" LG. 3 1/8"

EPO-118D



BUJE P/BARRA TENSOR INTERNATIONAL, HENDRICKSON E-4
EXT. 2 3/8" INT. 1" LG. 3 1/8"

EPO-132A

OEM:972901

GAFF:15013



BUJE P/TENSOR UNIVERSAL
EXT. 1 15/16" INT. 7/8" LG. 3"

EPO-123
 OEM:47692
 GAFF:14010/
 14091



BUJE P/TENSOR HENDRICKSON, REYCO
 2" INT. 7/8" LG. 3" EXT.

FYD-123N
 OEM:47692
 GAFF:14010/
 14091



BUJE P/TENSOR HENDRICKSON, REYCO
 2" INT. 7/8" LG. 3" EXT.

EPO-123A



BUJE P/TENSOR UNIVERSAL
 EXT. 2 1/16" INT. 7/8" LG. 3"

FYD-123AN



BUJE P/TENSOR HENDRICKSON, REYCO
 2" INT. 7/8" LG. 3" EXT.

EPO-339
 GAFF:13527



BUJE P/KIT DE REBOTE DE SUSPENSION
 HENDRICKSON
 EXT. 1 15/16" INT. 5/8" LG. 3"

EPO-340
 GAFF:11747



BUJE P/KIT DE REBOTE DE SUSPENSION
 HENDRICKSON
 EXT. 2 1/2" INT. 5/8" LG. 3 5/16"

EPO-1090



BUJE REBOTE DE SUSPENSION
 HENDRICKSON
 EXT. 2 13/16" INT. 1 1/8" LG. 80MM

EPO-1090U



BUJE REBOTE DE SUSPENSION
 HENDRICKSON
 EXT. 2 13/16" INT. 1 1/8" LG. 70MM

FYD-3626N
 OEM:64179037
 GAFF:13626



KIT SOPORTES SUSPENSION HENDRICKSON HAULMAAX

FYD-3601N
 OEM:49377000
 GAFF:13601



SOPORTE P/SUSPENSION HENDRICKSON
 LG: 10 7/8" WD: 8" H: 5 1/2" HO: 15/32" LG C-C: 6 7/8"

FYD-233K

DT1693K



KIT DE RONDANAS Y TUBO PARA BUJE TRIFUNCIONAL

EPO-233

OEM:B11613

GAFF:13542



RONDANAS P/SUSPENSION DE AIRE HENDRICKSON.
EXT. 7" INT. 2 3/8" ESP. 5/16"

FYD-523N

OEM:D25364

GAFF:13736



BUJE TRIDIFUNCIONAL CHICO HENDRICKSON
EXT. 6" INT. 1 1/4" ALT. 3 5/8"

FYD-275N

OEM:C3558

GAFF:13565



BUJE TRIDIFUNCIONAL P/SUSP. HENDRICKSON
EXT. 5 15/16" INT. 1 1/4" LG. 6 3/4

FYD-838N

OEM:A20681

GAFF:13541



BUJE INTERIOR HENDRICKSON
EXT. 1 1/4" INT. 1 1/8" LG. 6 3/4"

EPO-838

OEM:A20681

GAFF:13541



BUJE INTERIOR HENDRICKSON
EXT. 1 1/4" INT. 1 1/8" LG. 6 3/4"

EPO-815

OEM:R309416

GAFF:13625



SOPORTE AUXILIAR P/SUSPENSION HENDRICKSON
LG: 4 3/4" WD: 2 1/16" H: 2" HO: 11/32" LG C-C: 4 1/8"

FYD-3510N

GAFF:13510



KIT BUJE TRI-FUNCIONAL HENDRICKSON
EXT. 5 15/16" INT. 1 1/8"

EPO-3812

OEM:67778000

GAFF:13812



SOPORTE AUXILIAR PROGRESIVO P/SUSPENSION
LG: 4 7/8" WD: 5" H: 4 3/16"

EPO-3686

OEM:28947000

GAFF:13611



SOPORTE AUXILIAR P/SUSPENSION HENDRICKSON
LG: 4 11/16" WD: 5 3/32" H: 3 11/32"

<p>EPO-215</p> <p>OEM:45477</p> <p>GAFF:13514</p>		<p>EPO-292</p> <p>GAFF:11561</p>	
<p>BUJE P/BARRA DE TORSION HENDRICKSON, INTERNAT. EXT. 3" INT. 1 1/8" LG. 3 1/4"</p>		<p>BUJE P/TENSOR HENDRICKSON UNIVERSAL EXT. 1 3/4 INT. 1" LG. 3"</p>	
<p>FYD-292N</p> <p>GAFF:11561</p>		<p>EPO-488</p> <p>GAFF:13513</p>	
<p>BUJE P/TENSOR HENDRICKSON UNIVERSAL EXT. 1 3/4 INT. 1" LG. 3"</p>		<p>BUJE P/MUELLE. HENDRICKSON, INTERNATIONAL EXT. 2 1/2" INT. 1" LG. 4 23/32"</p>	
<p>EPO-1088</p>		<p>EPO-3791</p>	
<p>BUJE REBOTE DE SUSPENSIÓN HENDRICKSON EXT. 2 13/16" INT. 1 1/2" LG. 3 1/8"</p>		<p>BUJE PARA BARRA DE TORSION HENDRICKSON EXT. 1 31/32" EXT.< 1 13/16" INT. 7/8" LG. 3"</p>	
<p>FYD-833N</p> <p>OEM:5919000L</p> <p>GAFF:13505</p>		<p>FYD-1027N</p> <p>OEM:696900L</p> <p>GAFF:13501</p>	
<p>BUJE CENTRAL SUSPENSION HENDRICKSON MOD. S 380, 400 OD: 4 3/4" LG: 12" OD<: 3/2"</p>		<p>BUJE LATERAL P/SUSPENSION HENDRICKSON MOD. 340 EXT. 4 3/8" EXT.< 4 7/32 INT. 2 1/2" LG. 5 3/4"</p>	

EPO-078CM

OEM:64697000
GAFF:13582



GRANADA DE BOTELLA T/HENDRICKSON
EXT. 2" LG. 8 1/16"

EPO-092

OEM:46734
GAFF:13517



GRANADA EXCENTRICA P/SUSPENSION HENDRICKSON
EXT. 2 3/4" HO. 13/16" C.C. 5 11/16

EPO-125

OEM:44695000L
GAFF:13520



GRANADA PARA TENSOR KENWORTH, HENDRICKSON
EXT. 2 3/4" BARR. 13/16" C.C 4 3/8"

EPO-126

OEM:24476000
GAFF:11509



GRANADA P/TENSOR HENDRICKSON KENWORTH BIG SIX
EXT. 3 1/2" BARR. 21/32" LG. C-C 4 3/8"

EPO-157

OEM:A16119448
GAFF:13521



GRANADA P/TENSOR HENDRICKSON, FREIGHTLINER
EXT. 2" HO. 11/16" C-C 4 13/32

FYD-157N

OEM:A16119448
GAFF:13521



GRANADA P/TENSOR HENDRICKSON.
EXT. 2" HO. 11/16" C-C 4 13/32

EPO-208CM

OEM:229610
GAFF:13518



GRANADA T/BOTELLA HENDRICKSON, KENWORTH,
EXT. 2 3/4" ROSCA 1 1/4" LG. 8 1/16"

EPO-209CM

OEM:46735
GAFF:12031



GRANADA T/BOTELLA HENDRICKSON
EXT. 2 3/4" ROSCA. 1 1/4" LG. 7"

EPO-342

OEM:44695
GAFF:13536



GRANADA P/SUSPENSION HENDRICKSON
EXT. 2 15/16" BARR. 21/32" C.C 4 3/8"

EPO-343



GRANADA SUSPENSION HENDRICKSON
EXT. 3 1/16" LG. 8 1/16"

EPO-157B
 OEM:47691000L
 GAFF:13799



GRANADA P/TENSOR HENDRICKSON
 EXT. 1 31/32" HO. 11/16 C-C 4 3/8"

EPO-176
 OEM:57256
 GAFF:13618



GRANADA P/TENSOR HENDRICKSON
 EXT. 2 7/16" HO. 5/8 LG. C-C 4 3/8"

EPO-182
 OEM:47691
 GAFF:13598



GRANADA P/TENSOR, HENDRICKSON.
 EXT. 1 7/8" HO 21/32 C-C. 4 13/32"

EPO-211
 OEM:57256000
 GAFF:11714



GRANADA P/TENSOR HENDRICKSON, INTERNATIONAL
 EXT. 2 15/32" BARR. 21/32" LG.C-C 4 3/8"

EPO-212
 OEM:476991
 GAFF:13515



GRANADA EXCÉNTRICA HENDRICKSON.
 EXT. 3" BARR. 13/16" LG.C-C. 5 11/16"

EPO-536
 OEM:60383000
 GAFF:13627



GRANADA P/BIGRA DE TORSION HENDRICKSON
 EXT. 2 1/2" C.C. 5 17/32" BARR. 7/8" LG.TOTAL 7 1/8"

EPO-1158
 OEM:6440002L
 GAFF:11158



GRANADA P/SUSP. HENDRICKSON
 EXT. 2 25/32" HO 21/32" C.C 4 3/8"

EPO-3523
 GAFF:13523



GRANADA P/SUSP. HENDRICKSON
 EXT. 3" HO 13/16" C.C 5 7/8"

FYD-3580N
 OEM:3401388L
 GAFF:13580



GRANADA LATERAL HENDRICKSON
 OD: 4 3/8" LG: 4 21/32" HO: 1 1/16" LG C-C: 8 1/2"

EPO-3834
 OEM:TS0022500
 GAFF:13834



GRANADA /BARRA DE TORSION
 OD: 2" HO: 21/32" LG C-C: 4 3/8"

EPO-8909

OEM:6440003L

GAFF:18909



GRANADA P/SUSP. HENDRICKSON
EXT. 2 3/4" HO 13/16" C.C 5 1/4"

EPO-551



GRANADA P/BARRA DE TORSIÓN HENDRICKSON
EXT. 2 1/2" C-C. 6 1/4"

FRH-01



RONDANA DE ALINEACION HENDRICKSON EXCENTRICA
OD: 4" OD<: 1,240" ID: 7/8" ESP: 1/2"

FRH-02



RONDANA DE ALINEACION HENDRICKSON CONCENTRICA
OD: 4" OD<: 1,240" ID: 7/8" ESP: 1/2"

FRH-03

OEM:52770

GAFF:90030



ARANDELA DE ALINEACION SOLDABLE HENDRICKSON S-2770
OD: 4 1/2" OD<: 2 1/8" ID: 1 1/8" ESPESOR: 3/4"

FRH-04



RONDANA DE ALINEACION HENDRICKSON EXCENTRICA
OD: 4" OD<: 1,240" ID: 1" ESP: 1/2"

FRH-05



RONDANA DE ALINEACION HENDRICKSON CONCENTRICA
OD: 4" OD<: 1,240" ID: 1" ESP: 1/2"

EPO-037

OEM:UXA000011

GAFF:13000



BUJE TENSOR CONICO FRUEHAUF
EXT. 2 3/16" INT. 1 1/4"

FYD-037N

OEM:UXA000011

GAFF:13000



BUJE TENSOR CONICO FRUEHAUF
EXT. 2 3/16" INT. 1 1/4"

EPO-038

OEM:UXA000004

GAFF:13003



BUJE PARA BALANCIN CONICO T/FRUEHAUF
EXT. 3 1/2" INT. 2" ALT. 4 3/8"

FYD-038N

OEM:UXA000004

GAFF:13003



BUJE PARA BALANCIN CONICO T/FRUEHAUF
EXT. 3 1/2" INT. 2" ALT. 4 3/8"

EPO-017

GAFF:10003



PLANCHA P/ QUINTA
LG. 10 1/4" ANCHO. 3 3/4" ESP. 1"

EPO-128

OEM:UCA0472

GAFF:14000



BUJE CENTRAL P/BALANCIN FRUEHAUF, HUTCHENS.
EXT. 3 1/4" BARR. 3/4" LG. 3 7/8"

EPO-3037

OEM:UCD5635001

GAFF:13037



COJINETE PARA SUSPENSION FRUEHAUF
LG. 7 5/8" ANCHO. 4 3/4" ESP. 1"

PBA-024

GAFF:13015



PERNO P/TENSOR FRUEHAUF
OD: 1 1/4" LG: 7 1/4" THD: 1-14 NF

EPO-210



TACON P/SOPORTE DE TOLVA DE TRACTOCAMION
LG. 6" ANCHO. 3" ALT. 1 1/4"

PBA-020

GAFF:13011



PERNO P/BALANCIN FRUEHAUF
OD: 2" LG: 11" THD: 1-14 NF

BUJES PARA QUINTA

EPO-015

OEM:ASF035807

GAFF:10001



PLANCHA P/ QUINTA RUEDA SAF-HOLLAND BUS, SIMPLEX
 LG. 10 1/8" ANCHO 3 1/2" ESP. 5/8"

EPO-016



PLANCHA PARA QUINTA RUEDA
 LG. 10" ANCHO 3 1/2" ESP. 3/4"

EPO-030

OEM:BSH-150

GAFF:10002



BUJE P/QUINTA RUEDA FONTAINE
 EXT. 4" INT. 1 1/4" ALT. 2 1/4"

FYD-030N

OEM:BSH-150

GAFF:10002



BUJE P/QUINTA RUEDA FONTAINE
 EXT. 4" INT. 1 1/4" ALT. 2 1/4"

EPO-027

OEM:XA16045



BUJE P/QUINTA RUEDA KW-900, HOLLAND
 EXT. 2 3/4" INT. 1 1/8" LG. 4"

EPO-027A

OEM:XA16045

GAFF:11515



BUJE P/QUINTA RUEDA SAF- HOLLAND
 EXT. 2 13/16" INT.1 1/8" LG. 4"

EPO-044



BUJE P/QUINTA RUEDA KW TIPO VIEJO
 EXT. 3" INT. 2" LG. 4 1/8"

EPO-065

OEM:ASF032947

GAFF:10080



PLANCHA P/QUINTA RUEDA SAF-HOLLAND
 LG. 10" ANCHO. 3 9/16" ESP. 11/32"

EPO-153

OEM:XB00112

GAFF:11517



BUJE P/QUINTA RUEDA SAF - HOLLAND
 EXT. 2 1/8" INT. 1 1/8" LG. 4 7/32"

FYD-153N

OEM:XB00112

GAFF:11517



BUJE P/QUINTA RUEDA SAF - HOLLAND
 EXT. 2 1/8" INT. 1 1/8" LG. 4 7/32"

BUJES PARA QUINTA

EPO-238

OEM:348A

GAFF:18574



BUJE P/PUNTA DE DOLLING PREMIER
EXT. 3 1/2" INT. 2" LG. 3 1/2"

EPO-303



BUJE P/LANZA PREMIER
EXT. 3 1/2" INT. 1 7/8" LG. 4 1/2"

EPO-303A



BUJE P/QUINTA
EXT. 2 5/8" INT. 1 1/2" LG. 4 3/4"

EPO-335

OEM:ATP032803

GAFF:40056



SOPORTE P/TORRE DE QUINTA RUEDA SAF - HOLLAND
ANCHO. 4" ALT. 3" LG. 6"

EPO-534

OEM:BSH109L

GAFF:10079



BUJE P/QUINTA RUEDA FONTAINE
EXT. 3 1/16" INT. 1 1/4" ALT. 2 11/16" ALT 2 5/16"

EPO-458

OEM:XB10605

GAFF:40035



BUJE P/QUINTA T/HOLLAND NUEVO
EXT. 2 9/16" EXT.< 2 5/16 INT. 1 1/8"

FYD-458N

OEM:XB10605

GAFF:40035



BUJE P/QUINTA T/HOLLAND NUEVO
EXT. 2 9/16" EXT.< 2 5/16 INT. 1 1/8"

EPO-861

OEM:LNRBK107



JGO. DE MEDIA CAÑAS P/QUINTA FONTAINE T/NUOVO
EXT. 5" INT. 4 1/8" ANCHO 3"

EPO-048



MEDIA CAÑA P/ SUSPENSION HT300
LG. 7 1/4" ANCHO. 5 1/8" ESPESOR. 5/8"

EPO-868

OEM:448-A

GAFF:18575



BUJE P/GANCHO DE DOLY PREMIER
EXT. 3 1/2" INT. 2 1/16" LG. 1 3/4"

BUJES PARA QUINTA

EPO-1724

OEM:XB00123
GAFF:11724



BUJE P/QUINTA RUEDA SAF – HOLLAND
ID: 1 1/2" LG: 4 3/16" WD: 2 19/32" H: 2 11/32"

EPO-3000

PHM:TTP0052
OEM: BSH3000



BUJE PARA QUINTA OVALADO TIPO FONTAINE

EPO-8094

OEM:XB00111
GAFF:18094



BUJE P/QUINTA SAF – HOLLAND
OD: 2 3/32" ID: 1 1/8" LG: 4 3/8"

EPO-8221

OEM:XB0009
GAFF:18221



BUJE P/QUINTA RUEDA SAF - HOLLAND
EXT. 3 1/2" INT. 1 1/4" LG. 3 3/4"

EPO-720191

DUROTHANE:DT250
GAFF:18558



2026

BUJE P/GANCHO DOLLY PREMIER VRMS
EXT. 4 3/16" INT. 2" LG. 4 1/2"

S A F / H O L L A N D



FYD-1078N

OEM:90008247

GAFF:50046



BUJE PIVOTE P/SUSPENSION SAF - HOLLAND
EXT. 4 5/8" INT. 1 1/8" LG. 5"

FYD-4536N

OEM:AS5727267

GAFF:14536



GRANADA PARA VIGA SAF - HOLLAND NEWAY
OD: 3 1/8" HO: 1 LG C-C: 6 1/4"

C H A L M E R S

EPO-999

OEM:22128

GAFF:18920



BUJE P/BARRA DE TORSION CHALMERS
OD: 3 21/32" OD<: 3 3/16" ID: 2 3/8" LG: 3 3/4"

EPO-1739

OEM:800010

GAFF:11739



BUJE P/BARRA DE TORSION CHALMERS
OD: 4 1/4" OD<: 3 1/2" ID: 2 19/32" LG: 4 5/32"

FYD-11740N

OEM:15002

GAFF:11740



SOPORTE DE CARGA PARA MUELLE CHALMERS
OD: 9 1/4" ID: 2" LG: 8"

EPO-466H

GAFF:10005



SOPORTE P/ CABINA DINA 9400

EXT. 2 7/8" EXT.< 1 3/4" INT. 5/8" LG. 2 11/16"

EPO-30504

GAFF:30504



SOPORTE P/ESCAPE DINA,

EXT. 2 11/32" EXT.< 1 1/4" INT. 17/32" LG. 1 11/16"

EPO-052

OEM:J6210-49

GAFF:10018



SOPORTE MOTOR, DINA, KENWORTH

EXT. 3" EXT.< 2" INT. 5/8" ALT. 2 1/4

EPO-052H

OEM:J6210-49

GAFF:10018



SOPORTE MOTOR, DINA, KENWORTH

EXT. 3" EXT.< 2" INT. 5/8" ALT. 2 1/4

EPO-070

OEM:71085180

GAFF:30505



GOMA P/ HORQUILLA DE SUSPENSION DINA AVANTE

EXT. 2 13/16" INT. 1 1/8" ALT 1 5/8"

EPO-295



SOPORTE P/MOTOR DINA FAMSA

EXT. > 3 1/2" EXT. < 1 15/16" INT. 3/4" LG. 2 5/16"

EPO-018

GAFF:30503



SOPORTE TRASERO P/MOTOR DINA MOD. 531, 210.

EXT. 4 1/2" INT. 15/16" ALT. 2 7/16"

EPO-465

OEM:753997C93

GAFF:10019



SOPORTE P/ CABINA DINA, KENWORTH

EXT. 3" EXT.< 1 13/16" INT. 5/8" LG. 1 15/16"

EPO-280

GAFF:10009



SOPORTE P/ CABINA DINA

LG. 2 13/16" ALT. 1 15/16"

EPO-489



SOPORTE P/ CABINA INTERNATIONAL, FAMSA

EPO-050

OEM:49841332



TACON INFERIOR P/RADIADOR MASA SOMEX
LG. 6" ALT. 7/8" BARR. 9/16"

EPO-162

GAFF:10017



BUJE P/ SOPORTE DELANTERO DE MOTOR DINA 531-210
EXT. 2 3/8" INT. 3/4" LG. 3 3/4"

EPO-118C

GAFF:10000



BUJE P/BARRA TENSOR INTERNATIONAL, HENDRICKSON E-4
EXT. 2 3/8" INT. 7/8" LG. 3 1/8"

EPO-178

GAFF:30539



BUJE P/AMORTIGUADOR DINA
EXT. 1 15/16" INT. 3/4" ALT. 1"

EPO-178B

OEM:1134962

GAFF:31017



BUJE P/AMORTIGUADOR DINA
EXT. 2 1/8" INT. 1" ALT. 1 3/16"

EPO-200



BARRA SOPORTE DE RADIADOR DINA
ANCHO. 2" ESP. 3/4" LG. 7 3/4"

EPO-308



SOPORTE P/MOTOR DINA
LG. 6 1/8" ALT. 1 9/16"

FYD-315N



TAPON PARA TAPA DE PUNTERIAS DINA
EXT. 2 3/8" INT 3/8" ESP. 1 3/16"

EPO-349

OEM:286235



SOPORTE DELANT P/MOTOR NAVISTAR
ALT. 1 1/2" LG. 5" ANCHO. 1 1/2"

EPO-350

OEM:286236C2



SOPORTE DELANT. P/MOTOR NAVISTAR
ALT. 1 1/2" LG. 6 3/8" ANCHO. 2 1/4"

D I N A

FYD-324N



GOMA P/RADIADOR FAMSA FREIGHTLINER

FYD-857N

GAFF:10008



SOPORTE DELANTERO P/CABINA DINA

EPO-1053



BUJE PARA AMORTIGUADOR DINA, VOLVO
EXT. 1 1/2" INT. 5/8" LG. 2"

EPO-1054



BUJE PARA AMORTIGUADOR DINA
EXT. 1 1/2" INT. 3/4" LG. 2"

FYD-6076N

STAR:6075

GAFF:11522



GOMA CASETA CUMMINS, DINA
EXT. 3" INT. 5/8" ALT. 1 3/16"

FYD-6077N

STAR:6077



GOMA CASETA CUMMINS, DINA
EXT. 3 3/4" INT. 3/4" ALT. 2"

PARTES THERMO KING

EPO-1026

OEM:TK928893

GAFF:18015



SOPORTE P/MOTOR THERMO KING MACK
EXT. 1 7/8 INT. 17/32 ALT. 2"

EPO-1026A

OEM:730016002

GAFF:50054



SOPORTE P/MOTOR THERMO KING MACK
EXT. 1 7/8 INT. 5/8 ALT. 2"

EPO-247

OEM:15588632

GAFF:16040



SOP. P/ BARRA ESTABILIZAD. KODIAK CHEVROLET C7500
(90-09) EXT. 3 3/32" INT. 1 13/16" LG. 3 5/32"

EPO-858

OEM:15624948

GAFF:16035



SOP. DELANTERO P/MOTOR KODIAK 2000 CHEVROLET
EXT. 3 25/32" INT. 5/8" LG. 2 1/2"

EPO-440

OEM:1506314

GAFF:18847



SOP. TRASERO P/MOTOR DER. SUP. KODIAK MOD. 98-06
EXT. 4" INT. 5/8" ALT. 3 1/16"

FYD-045AN



TOPE P/CHASIS DELANTERO DE KODIAK TORNILLO
MAS LARGO

FYD-045N



TOPE P/CHASIS TRAS. DEL KODIAK (1990-2009)
EXT. 3 9/16" INT. 1" ALT. 3 1/2"

FYD-404



SOPORTE DELANTERO P/MOTOR
CATERPILLAR CLASE C-2 KODIAK

EPO-74754

OEM:15574754



BUJE DE BARRA ESTABILIZADORA DELANTERO KODIAK
(1999-2008)

EPO-1083

OEM:S-21099

GAFF:13648



ARANDELA P/BUJE TRI-FUNCIONAL ARVIN MERITOR

OD: 7 7/16" ID: 2 15/16" TK: 1/4"

FYD-3751N

OEM:212009133

GAFF:13751



BUJE TRI-FUNCIONAL ARVIN MERITOR

OD: 6" ID: 1 19/32" LG: 5 1/4"

FYD-3752N

OEM:A1225N1522

GAFF:13752



BUJE TRI-FUNCIONAL ARVIN MERITOR

OD: 6" ID: 7/8" LG: 4 3/4"

FYD-3772N

OEM:21227380

GAFF:13772



BUJE FUNCIONAL ARVIN MERITOR

OD: 6" ID: 1 17/32" LG: 5 3/4"

EPO-128

OEM:UCA0472

GAFF:14000



BUJE CENTRAL P/BALANCIN ARVIN MERITOR, HUTCHENS,
EXT.3 1/4" BARR. 3/4" LG. 3 7/8" CC. 1 11/32"

EPO-8701

OEM:SP7155X1

GAFF:18701



BUJE PARA BALANCIN ARVIN MERITOR/ REYCO
OD: 2 1/4" ID: 1 3/16" LG: 4"

EPO-116



BUJE CENTRAL P/BALANCIN TRAILMOBILE
EXT. 3 5/16" BARR. 3/4" LG. 4 3/8"

FYD-761

OEM:L1191

L-266-A



BUJE T/ROTULA GAVILAN ARVIN MERITOR
EXT. 2 15/32" INT. 1 1/2" LG. 1 1/2"

FYD-762

OEM:266B



BUJE PARA LEVA DE FRENO TIPO ROTULA
EXT. 2 7/16" INT. 1 5/8" LG. 1 1/2"

FYD-763

OEM:M10WJ175

OEM:L266



BUJE PARA LEVA DE FRENO DOBLE LIGA
EXT. 2" INT. 1 1/2" LG. 2"

FYD-764B

OEM:L266E



BUJE PARA GAVILAN

EXT. 2" INT. 1 5/8" LG. 2"

FYD-765B



BUJE PARA GAVILAN

EXT. 1 7/8" INT. 1 1/2" LG. 2"

FYD-17501N

OEM:L1208



BUJE PARA LEVA DE FRENO ARVIN MERITOR

EXT. 1 7/8" INT. 1 1/2" LG. 1 3/16"

FYD-17505N

OEM:R657003



BUJE PARA LEVA DE FRENO TIPO CORONA

EXT. 2 3/16" EXT. 2" INT. 1 1/2" LG. 7/8"

FYD-17504N

OEM:1225B834



BUJE PARA LEVA DE FRENO

EXT. 1 29/32" INT. 1 5/8" LG. 1 1/8" HO 7/32"

FYD-17679N

OEM:730



BUJE PARA GAVILAN TIPO SUDISA

EXT. 2" INT. 1 1/2" LG. 1"

FYD-846B



ARANDELA P/BUJE 11205 MERITOR EXT. 7 1/2" INT. 2 1/2"

EPO-8961

OEM:A9423260050

GAFF:18961



GRANADA P/SUSP. MERCEDES BENZ BUS
EXT. 3 3/8" HO. 13/16 C.C. 5 1/8"

EPO-446

GAFF:31608



BUJE P/BARRA ESTABILIZADORA MERCEDES BENZ BUS
EXT.1 7/8" INT. 5/8" LG. 1 7/8"

EPO-8882

GAFF:18882



BUJE P/BARRA ESTABILIZADORA MERCEDES BENZ BUS
OD: 2 25/32" ID: 7/8" LG: 2 17/32"

EPO-448

OEM:0003320450

GAFF:31508



BUJE P/BARRA TORSION MERCEDES BENZ BUS
OD: 3 19/32" ID: 2 1/8" LG: 3 5/16"

FYD-91648N



SOPORTE P/MOTOR TRASERO OL916/48

FYD-37081N

OEM:3843237081



BUJE P/ BARRA ESTABILIZ. MERC. BENZ TORINO (2008-2015)
EXT. 2 17/32" INT. 1 17/32" LG. 2 3/8"

FYD-420143N



REPUESTO P/TRANSMISION DE CHASIS TORETO MERCEDES BENZ

FYD-3753260050

OEM:9413260050



BUJE P/BARRA ESTABILIZ. MERC. BENZ ACTROS, ATEGO Y AXOR.

FYD-1680N

OEM:A9793200444

GAFF:31680



BUJE BARRA ESTABILIZ. AYCO TORERO MERCEDES BENZ BUS
OD: 2 3/16" ID: 1 9/32" LG: 1 29/32"

FYD-1632N

OEM:OH1632/52LA



GRANADA P/ SUSPENSION MERCEDES BEZ
OH1632/52LA MOD. 2017
EXT. 88 mm HO.21 mm C.C. 130 mm

<p>EPO-057</p> <p>OEM:A6853260081</p> <p>GAFF:31658</p>  <p>BUJE P/ BARRA ESTABILIZADORA MERCEDES BENZ BUS EXT. 1 1/2" INT. 9/16" LG. 1 7/8"</p>	<p>EPO-028</p> <p>OEM:6883207173</p> <p>GAFF:31627</p>  <p>BUJE BARRA ESTABILIZ. MERCEDES BENZ BUS LO814/LO915 EXT. 1 3/16" INT. 1/2" LG. 1 5/16"</p>
<p>EPO-464</p>  <p>BUJE MUELLE DE MINIBUS MERCEDES BENZ EXT. 2 1/16" INT. 1 3/16" LG. 3 3/8"</p>	<p>EPO-455</p> <p>OEM:6883200044</p> <p>GAFF:31639</p>  <p>BUJE MUELLE MERCEDES BENZ BUS EXT. 2 5/16" INT. 1 7/16" LG. 3 3/8"</p>
<p>EPO-1001</p>  <p>BUJE BARRA DELANT. MERCEDES BENZ MICRO AUTOBUS EXT. 1 7/8" INT. 9/16"</p>	<p>EPO-441</p> <p>GAFF:31680</p>  <p>BUJE BARRA ESTABILIZ. MERCEDES BENZ BUS, IRIZAR 2002 EXT. 2 1/4" INT. 7/8" LG. 2 1/2"</p>
<p>EPO-1002</p>  <p>BUJE P/BARRA TRASERA MERCEDES BENZ MICRO AUTOBUS EXT. 53 MM INT. 40MM</p>	<p>EPO-366</p> <p>OEM:0003220385</p> <p>GAFF:31596</p>  <p>BUJE P/MUELLE MERCEDES BENZ BUS, ALLEGRO. EXT. 2 7/16" INT. 1" LG. 3 1/2"</p>
<p>FYD-1679N</p> <p>OEM:3183200073</p> <p>GAFF:31679</p>  <p>BUJE P/BARRA ESTABILIZ. MERCEDES BENZ BUS TORETTA OD: 1 15/32" ID: 21/32" LG: 1 1/2"</p>	<p>EPO-479</p> <p>OEM:3203230044</p> <p>GAFF:31512</p>  <p>BUJE ESTABILIZADORA MERCEDES BENZ EXT. 3" INT. 1 1/8" ALT. 1 1/16"</p>

EPO-1550

OEM:0019872640

GAFF:31550



SOPORTE P/RADIADOR MERCEDES BENZ BUS
OD: 1 5/32" LG: 2 7/32" THD: M8X1.25

EPO-204

GAFF:31566



GOMA P/ BARRA ESTABILIZ. MERCEDES BENZ BUS ALLEGRO
EXT. 2" INT. 1 9/16" ESP. 1 3/4"

EPO-1611

GAFF:31611



GOMA P/BARRA ESTABILIZADORA MERCEDES BENZ BUS
ID: 1 3/4" LG: 2 1/16"

EPO-300

GAFF:31565



BUJE P/BARRA ESTABILIZ. MERCEDES BENZ BUS BOXER
EXT. 2 5/16" EXT.< 1 25/32 INT. 19/32" ESP. 3/4"

EPO-095

GAFF:31567



GOMA P/BARRA ESTABILIZ. MERCEDES BENZ BUS ALLEGRO
EXT. 1 13/32" EXT.< 21/32 INT. 7/16" ALT. 15/16"

EPO-165



GOMA P/AMORTIGUADOR MERCEDES BENZ
EXT. 1 3/4" INT. 9/16" ESP. 7/8"

EPO-367

OEM:90036192

GAFF:31588



RONDANA P/BUJE TRI-FUNCIONAL. MERCEDES.BENZ BUS
EXT. 5 1/4" INT. 1 3/4" ALT. 1/4"

EPO-1000



BUJE P/BARRA DELANTERA MERCEDES
BENZ MICRO AUTOBUS
EXT. 2 1/2" INT. 39MM

EPO-1514

OEM:3013260081

GAFF:31514



BUJE P/BARRA ESTABILIZADORA MERCEDES BENZ BUS
LG: 3 1/8" WD: 3 1/4" H: 19/16"

EPO-449

GAFF:12328



SOPORTE P/ RADIADOR MERCEDES BENZ
ALT. 1 8" ANCHO. 2 1/4" LG. 2 7/8"

EPO-105



BUJE P/ BARRA DE TORSION TRASERO MERCEDES BENZ
EXT. 4" INT. 2 1/8" ALT. 1 1/2"

FYD-316N



SOPORTE DE RADIADOR MERCEDES BENZ
EXT. 2 1/8

EPO-1502

OEM:3073230044

GAFF:31502



BUJE P/AMORTIGUADOR MERCEDES BENZ BUS
EXT.1 13/16" INT. 3/4" ESP. 13/16"

FYD-9333N

OEM:9743280181



BUJE P/ BARRA ESTABILIZ. SUSPENSION DELANT. MERC. BENZ
EXT. 47.5 mm INT. 22.5 mm LG. 40 mm

EPO-365

GAFF:31638



SOPORTE DELANT. P/MOTOR MERCEDES BENZ
ANCHO 4" LG. 4 21/32"

FYD-365N

GAFF:31638



SOPORTE DELANT. P/MOTOR MERCEDES BENZ
ANCHO 4" LG. 4 21/32"

EPO-147



BUJE PARA MUELLE Z" MERCEDES BENZ
EXT. 2 5/16" INT. 1" LG. 3"

FYD-562N

APA:562



SOPORTE DELANT. P/MOTOR MERCEDES BENZ (1990-1991)

EPO-1600

OEM:6952400217

GAFF:31600



SOPORTE P/MOTOR MERCEDES BENZ BUS
EXT. 4 5/16" INT. 21/32" LG. 3 11/32" TORN. 5/8 X

EPO-1633

OEM:3200144

GAFF:31633



BUJE P/AMORTIGUADOR MERCEDES BENZ BUS
OD: 1 19/32" ID: 9/16" LG: 1 21/32"

EPO-1601



GRANADA P/SUSP. MERCEDES BENZ BUS
EXT. 2 27/32" HO.1" C.C. 5 1/8"

EPO-1602

OEM:0003502405

GAFF:31602



GRANADA P/SUSP. MERCEDES BENZ BUS
EXT. 3 15/16" HO.1" C.C. 6"

EPO-8962

OEM:A-3683500405

GAFF:18962



BUJE P/TENSOR MAN BUS, VOLVO BUS
EXT. 3 5/16" HO. 1" C.C. 6"

FYD-10039N



BUJE P/BARRA ESTABILIZADORA MICROBUS MERCEDES BENZ
EXT. 2 1/8" INT. 1 1/8" LG.2"

EPO-1447N



BUJE P/MUELLE SPRINTER MERCEDES BENZ VANS
OD: 1 3/16" ID: 9/16" LG: 3"

FYD-7663N



BUJE P/MUELLE SPRINTER MERCEDES BENZ VANS
OD: 1 15/16" ID: 5/8" LG: 72MM

FYD-7664N



BUJE P/MUELLE SPRINTER MERCEDES BENZ VANS
OD: 1 9/16" ID: 5/8" LG: 72MM

FYD-7665N



BUJE P/MUELLE SPRINTER MERCEDES BENZ VANS
OD: 2 3/16" ID: 9/16" LG: 3"

<p>EPO-202</p> <p>OEM:90008149</p> <p>GAFF:14528</p> <p>GAFF:14533</p>		<p>EPO-205</p> <p>OEM:90008139</p> <p>GAFF:14513</p>	
<p>BUJE LATERAL P/SUSP. INTERNATIONAL TRUCK/NEWAY EXT. 2 13/16" INT. 1 1/8" LG. 5"</p>		<p>BUJE LATERAL P/SUSPENSION AIRE NEWAY AR-41. EXT. 3 1/2" INT. 1 1/8" LG. 5 1/4"</p>	
<p>EPO-444</p> <p>OEM:90008151</p> <p>GAFF:14514</p>		<p>EPO-445</p> <p>OEM:90008006</p> <p>GAFF:31592</p>	
<p>BUJE LATERAL NEWAY, INTERNATIONAL TRUCK EXT. 3 1/2" INT. 1 1/8" LG. 5"</p>		<p>BUJE LATERAL MERCEDES BENZ EXT. 3 7/8" INT. 2 1/2" LG. 5 1/4"</p>	
<p>EPO-360</p> <p>OEM:90008008</p> <p>GAFF:14527</p>		<p>EPO-284</p> <p>OEM:90008266</p> <p>GAFF:14538</p>	
<p>BUJE LATERAL NEWAY EXT. 3 7/8" INT. 2 1/2" LG. 5 3/4"</p>		<p>BUJE LATERAL NEWAY ADZ-126/123 EXT. 3 3/16" INT. 1 1/8" LG. 4"</p>	
<p>EPO-036</p> <p>GAFF:14510</p>		<p>EPO-036A</p> <p>GAFF:14504</p>	
<p>BUJE P/VIGA DE SUSPENSION NEWAY EXT. 2 3/8" INT. 1 1/8" LG. 5"</p>		<p>BUJE P/VIGA DE SUSPENSION NEWAY EXT. 2 3/8" INT. 1 1/4" LG. 5"</p>	
<p>EPO-021</p> <p>OEM:91008022</p> <p>GAFF:14521</p>		<p>EPO-336</p> <p>OEM:91038210</p> <p>GAFF:14500</p>	
<p>BUJE SUSPENSION TS, US, USR. NEWAY EXT. 4 31/32" INT. 4" LG. 8 3/4"</p>		<p>BUJE P/MUÑON NEWAY EXT. 4 1/2" INT. 3 1/2" LG. 8 3/4"</p>	

EPO-337

OEM:90008011

GAFF:14501



BUJE P/BALANCIN NEWAY

EXT. 4 1/2" INT. 3 1/2 LG. 6 3/4"

EPO-4522

OEM:91028089

GAFF:14522



COJINETE P/EJE NEWAY

LG: 5 1/8" WD: 4 1/2" TK: 3/4"

EPO-4537

GAFF:14537

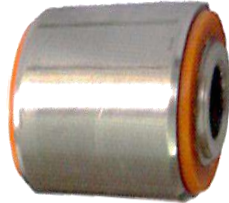

BUJE P/BARRA ANGULAR SUSPENSION NEWAY

OD: 2 3/4" ID: 1 1/32" LG: 2 27/32"

FYD-845N

GAFF:18320



JUNTA P/TAPON DIESEL EN NITRILO

EXT. 3 1/2" INT. 2 27/32" ESP. 3/32"

FYD-1008N

OEM:90008175

GAFF:14532



GRANADA P/TENSOR NEWAY

EXT. 3 27/32" HO. 1 1/16" LGC-C. 8 1/2" LG. 10 3/4"

FYD-4536N

OEM:90008267

GAFF:14536



GRANADA P/ VIGA NEWAY/SAF-HOLLAND ADZ

OD: 3 1/8" HO: 1" LG C-C: 6 1/4"

EPO-14505

OEM:91028039



COJINETE PARA SUSPENSION

LG: 10 3/8" WD: 5" TK: 13/16"

EPO-14523

OEM: 91008006



MEDIO BUJE SUPERIOR PARA BALANCÍN

ID: 2 25/32" LG: 4 5/32" H: 1 31/32" TK: 15/32"

EPO-14524



MEDIO BUJE INFERIOR PARA BALANCÍN

ID: 1 7/16" LG: 4 3/32" WD: 3 13/16"

EPO-069H

OEM:J71651

GAFF:11522

STAR:6076



SOPORTE P/RADIADOR PETERBILT FREIGHTLINER,
EXT. 2 7/8" EXT.< 1 13/16 INT.5/8" ALT. 1 1/4"

EPO-1527

OEM:K066-177

GAFF:11527



SOPORTE P/ CABINA PETERBILT
EXT. 2 5/8" EXT. 1 9/16" INT. 5/8" ALT. 2 1/16"

EPO-1554

OEM:1301633

GAFF:11554



SOPORTE P/RADIADOR PETERBILT, KENWORTH
EXT. 1" EXT.< 27/32 INT.13/32" ALT. 1"

EPO-1707

OEM:M501/505968

GAFF:11707



SOPORTE P/ CABINA PETERBILT T800 2005
EXT. 2 1/2" EXT. 1 19/32" INT. 5/8" ALT. 2"

EPO-225

OEM:508968

GAFF:12355



SOPORTE P/MOTOR PETERBILT
EXT. 2 1/2" EXT.< 1 5/8" INT. 21/32" ALT. 2 1/32"

EPO-473

OEM:510197

GAFF:12356



SOPORTE P/MOTOR PETERBILT
OD: 2 11/16" ID: 13/16" LG: 2 13/32" OD<: 1 19/32"

EPO-2370

GAFF:12370

OEM:1304154



SOPORTE P/COFRE PETERBILT MOD.379 1987
OD: 1 25/32" ID: 1/2" LG: 5/8" OD<: 1 3/16"

EPO-2368

OEM:CB220370

GAFF:12368



SOPORTE TRASERO P/ MOTOR PETERBILT 1987
OD: 2 17/32" ID: 25/32"

EPO-2369

OEM:CB220372

GAFF:12369



SOPORTE TRASERO P/ MOTOR PETERBILT 379
OD: 2 17/32" ID: 21/32"

EPO-2367

OEM:1304588

GAFF:12367



BUJE PARA BISAGRA DE COFRE KENWORTH/PETERBILT
EXT. 1 5/16" INT. 1/2" LG. 2"

EPO-2409

OEM:1304427

GAFF:12409



BUJE P/BISAGRA DE COFRE PETERBILT
 OD: 1 23/32" ID: 5/8" LG: 1 27/32" OD<: 1"

EPO-2410

OEM:1304164

GAFF:12410



BUJE P/BISAGRA DE COFRE PETERBILT MOD.379 1987
 ID: 1/2" LG: 2 1/4" WD: 2" H: 5/8"

EPO-327



SOPORTE P/CARROCERIA DE AUTOBUS PETERBILT
 EXT. 3 7/16" LG. 3 3/16" ALT. 2 1/2" BARR. 3/4"

EPO-352

OEM:1314711

GAFF:12359

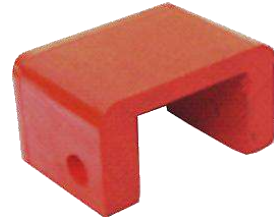

SOPORTE PARA CABINA PETERBILT 1987
 ALT. 2" LG. 3 1/8" ANCHO. 2 3/8"

EPO-046

OEM:0301674

GAFF:12350



BUJE BARRA DE SUSPENSION DE AIRE PETERBILT AIR LEAF
 EXT. 2 1/2" INT.1 3/4" LG. 2 1/2"

EPO-870

OEM:0301675

GAFF:12351



BUJE P/SUSPENSION PETERBILT AIRLEAF/LOW
 EXT. 2 5/8" INT. 1 3/4" LG. 7/8"

EPO-208CM

OEM:229610

GAFF:13518



GRANADA T/BOTELLA PETERBILT, HENDRICKSON, KW,
 EXT. 2 3/4" ROSCA 1 1/4" LG. 8 1/16"

EPO-125

OEM:4444695000L

GAFF:12320



GRANADA PARA TENSOR PETERBILT KW, HENDRICKSON
 EXT. 2 3/4" BARR. 21/32" C.C 4 3/8"

EPO-157

OEM:A1611944448

GAFF:13521



GRANADA P/TENSOR PETERBILT, HENDRICKSON, KW.
 EXT. 2" HO. 21/32 C-C 4 13/32

EPO-155

OEM:151087148

GAFF:13522



GRANADA BARRA DE TORSION, PETERBILT, KW.
 EXT. 2 17/32" HO 21/32 C-C 4 3/8"

FYD-12360N

OEM:2008257

GAFF:12360



SOPORTE PARA CABINA PETERBILT
OD: 3 1/8" ID: 5/8" LG: 2 7/8"

FYD-10038N

OEM:1414656

GAFF:10038



SOPORTE PARA RADIADOR Y ESCAPE PETERBILT
OD: 1 5/16" ID: 13/32"

FYD-938N

OEM:L56-0001

GAFF:12365



GANCHO PARA COFRE PETERBILT LG: 8 7/8"

FYD-11109N

OEM:17-14781-000

GAFF:11109



GANCHO PARA COFRE PETERBILT

EPO-178A

OEM:373023403

GAFF:30507



BUJE P/AMORTIGUADOR PETERBILT, KENWORTH.
EXT. 1 15/16" ALT. 1" INT. 1"

EPO-12363

OEM:1303593

GAFF:12363



BUJE PARA COFRE PETERBILT MOD. 359/379 (1987) EXT. 1 1/2" INT. 21/32" LG. 1 9/16"

EPO-160

OEM:0891501

GAFF:15000



BUJE P/BALANCIN T/REYCO
EXT. 3 15/32" INT. 1" LG. 4"

EPO-163

DAI:9302



BUJE P/BALANCIN T/HUTCHENS REYCO
EXT. 3 15/32" INT. 1 1/8" LG. 4"

EPO-167

OEM:8995-01

GAFF:15000



BUJE P/BALANCIN T/REYCO
EXT. 3 1/8" INT. 1 1/4" LG. 4 1/2"

EPO-169

OEM:1471301

GAFF:15001



BUJE P/BALANCIN T/REYCO
EXT. 3 1/8" INT. 1 1/2" LG. 4 1/2"

EPO-235

OEM:T-3214

GAFF:15017



BUJE P/BALANCIN REYCO
EXT. 3 1/8" INT. 2" LG. 3 7/8"

EPO-278

OEM:064902

GAFF:14002



BUJE P/BALANCIN REYCO / HUTCHENS
EXT. 3 5/16" INT. 1" LG. 4"

EPO-278A

OEM:16146-01

GAFF:14038



BUJE P/BALANCIN HUTCHENS
EXT. 3 5/16" INT. 1 1/8" LG. 3 7/8"

EPO-285



BUJE P/BALANCIN REYCO
EXT. 3 1/8" INT. 1" LG. 4 1/2"

EPO-024H

OEM:T-5493

GAFF:15073



BUJE P/TENSOR T/HUCHENS H200
EXT. 2 11/32" EXT.<1 13/16 INT. 1" LG. 3"

EPO-043H

GAFF:15051



BUJE P/TENSOR T/ REYCO. MOD. 101/102
EXT. 2 13/32" EXT.<1 17/32" INT. 1 1/16" LG. 2 3/4"

EPO-043AH

OEM:T-2242

GAFF:15019



BUJE P/TENSOR T/ REYCO. MOD. 101/102
EXT. 2 3/8" EXT.<1 13/16 INT. 1" LG. 2 3/4"

EPO-141

OEM:T-1842

GAFF:15008



BUJE CONCENTRICO P/TENSOR REYCO
EXT. 3 1/8" EXT.<1 13/16 INT. 1 1/16" LG. 2 27/32

EPO-142

OEM:T-1723

GAFF:15009



BUJE EXCENTRICO P/TENSOR REYCO MOD. RANDOM
EXT. 3 1/16" EXT.<1 13/16 INT. 1" LG. 2 7/8

EPO-203

OEM:2123801

GAFF:15020



BUJE P/TENSOR REYCO MOD. 102
EXT. 3 5/32" EXT.<1 13/16 INT. 1" ALT. 2 11/16"

EPO-859

GAFF:15020



BUJE P/TENSOR TIPO REYCO
EXT. 3 1/8" EXT.<1 13/16" INT. 1" LG. 2 3/4"

EPO-4087

GAFF:14087



COJINETE PARA SUSPENSION HUTCHENS
LG. 5" ANCHO 2 7/8" ESPESOR 13/16

EPO-003

GAFF:15005



BUJE CENTRAL P/SUSPENSION REYCO MOD. PREMIER
EXT. 4" INT. 2 3/8"

EPO-003A

GAFF:15006



BUJE CENTRAL P/SUSPENSION REYCO MOD. PREMIER
EXT. 4" INT. 2 1/2"

EPO-128

OEM:UCA-0472

GAFF:14000



BUJE CENTRAL P/BALANCIN FRUEHAUF, HUTCHENS.
EXT. 3 1/4" BARR. 3/4" LG. 3 7/8"

EPO-004A

PARBO:PBJ-1064



BUJE P/CANILLA SUSPENSION SULTANA RAMIREZ
EXT. 3 5/8" INT. 2 7/16"

EPO-032

OEM:31216

GAFF:14004



BUJE P/TENSOR TRAILMOBILE
 EXT. 2 5/16" EXT. < 1 29/32" INT. 1 5/16" LG. 2 3/16"

EPO-099



BUJE P/TENSOR UNIVERSAL
 EXT. 1 7/8" INT. 3/4" LG. 3"

EPO-100



BUJE P/TENSOR UNIVERSAL
 EXT. 1 27/32" INT. 1" LG. 3"

EPO-101



BUJE P/TENSOR UNIVERSAL
 EXT. 1 25/32" INT. 1" LG. 3"

EPO-102



BUJE P/TENSOR UNIVERSAL
 EXT. 1 27/32" INT. 7/8" LG. 3"

EPO-102A

DAI:9006



BUJE P/TENSOR UNIVERSAL
 EXT. 1 7/8" INT. 7/8" LG. 3"

EPO-117

DAI:9037



BUJE P/SUSPENSION HUTCHENS
 EXT. 2 1/2" INT. 1 1/2" LG. 4 1/8"

EPO-118C

GAFF:10000



BUJE P/BARRA TENSOR INTERNATIONAL, HENDRICKSON E-4
 EXT. 2 3/8" INT. 7/8" LG. 3 1/8"

EPO-119H

DAI:9009-B













BUJE P/TENSOR UNIVERSAL CONICO
 EXT. 2" INT. 1" LG. 3"

EPO-121



BUJE P/TENSOR UNIVERSAL
 EXT. 1 25/32" INT. 7/8" LG. 3"

<p>EPO-122</p> <p>OEM:34734</p> <p>GAFF:14031</p>  <p>BUJE P/TENSOR UNIVERSAL EXT. 1 3/4" INT. 7/8" LG. 3"</p>	<p>EPO-123</p> <p>OEM:47692</p> <p>GAFF:14010</p>  <p>BUJE P/TENSOR REYCO / HENDRICKSON EXT. 2" INT. 7/8" LG. 3"</p>
<p>EPO-123A</p>  <p>BUJE P/TENSOR UNIVERSAL EXT. 2 1/16" INT. 7/8" LG. 3"</p>	<p>EPO-124</p> <p>DAI:9313</p>  <p>BUJE P/TENSOR UNIVERSAL EXT. 1 13/16" INT. 7/8" LG. 3"</p>
<p>EPO-1028</p>  <p>BUJE P/TENSOR UNIVERSAL EXT. 1 13/16" INT. 5/8" LG. 3"</p>	<p>EPO-1029</p>  <p>BUJE P/TENSOR UNIVERSAL EXT. 1 13/16" INT. 3/4" LG. 3"</p>
<p>EPO-129H</p> <p>DAI:9004</p>  <p>BUJE P/TENSOR UNIVERSAL EXT. 2" INT. 1" LG. 3"</p>	<p>EPO-129HA</p>  <p>BUJE P/TENSOR UNIVERSAL EXT. 2" INT. 7/8" LG. 3"</p>
<p>EPO-129HB</p>  <p>BUJE P/TENSOR UNIVERSAL EXT. 2 1/8" INT. 1" LG. 3"</p>	<p>EPO-129HC</p>  <p>BUJE P/TENSOR UNIVERSAL EXT. 2" INT. 1 1/4" LG. 3"</p>

EPO-132

OEM:722-00

GAFF:14073



BUJE P/TENSOR UNIVERSAL
EXT. 1 15/16" INT. 1" LG. 3"

EPO-132A

OEM:0972901

GAFF:15013



BUJE P/TENSOR REYCO, HENDRICKSON, VOLVO TRUCK
EXT. 1 15/16" INT. 7/8" LG. 3"

EPO-134

GAFF:14015



BUJE P/TENSOR UNIVERSAL
EXT. 1 13/16" INT. 1" LG. 3"

EPO-145



BUJE P/TENSOR UNIVERSAL
EXT. 2 1/16" INT. 1" LG. 3"

EPO-145A



BUJE P/TENSOR UNIVERSAL
EXT. 2 1/16" INT. 1 1/4" LG. 3"

EPO-279



BUJE P/BALANCIN HUTCHENS
EXT. 6" INT. 5" LG. 7"

EPO-338

GAFF:14027



BUJE P/BALANCIN HUTCHENS
EXT. 5" INT. 4" LG. 9"

EPO-516

DAI:9289



BUJE P/TENSOR UNIVERSAL
EXT. 1 7/8" INT. 1" LG. 3"

EPO-495



BUJE P/ SUSPENSION VILCHIS
EXT. 2 1/2" INT. 1 1/2" LG. 4 1/2"

EPO-1014



BUJE PARA TENSOR UNIVERSAL
EXT. 2 1/4" INT. 7/8" LG. 3"

EPO-4010

OEM:47692

GAFF:14010



BUJE P/BARRA DE TORSION HENDRICKSON/REYCO
EXT. 2" INT. 7/8" LG. 3"

EPO-8701

OEM:SP7155X1

GAFF:18701



BUJE PARA BALANCIN ARVIN MERITOR/ REYCO
OD: 2 1/4" ID: 1 3/16" LG: 4"

GOMAS CARDAN SPICER

EPO-082

OEM:2301261

GAFF:18000



SOPORTE P/EJE CARDAN SPICER, VOLKSWAGEN BUS 508
EXT. 5 3/16" INT. 3 5/32" ALT. 5"

FYD-082N

OEM:2301261

GAFF:18000



SOPORTE P/EJE CARDAN SPICER, VOLKSWAGEN BUS 508
EXT. 5 3/16" INT. 3 5/32" ALT. 5"

EPO-083

GAFF:18726



SOPORTE CARDAN SPICER 509
EXT. 5 3/8" INT. 3 3/8"

FYD-083N

GAFF:18726



SOPORTE CARDAN SPICER 509
EXT. 5 3/8" INT. 3 3/8"

EPO-084

GAFF:18725



SOPORTE P/EJE CARDAN 510- 280
ID: 3 1/16" LG: 5 19/32" H: 5 1/2" TK: 2"

FYD-084N

GAFF:18725



SOPORTE P/EJE CARDAN 510- 280
ID: 3 1/16" LG: 5 19/32" H: 5 1/2" TK: 2"

EPO-085

OEM:2106611X

GAFF:18002



SOPORTE P/EJE CARDAN SPICER 512- 281
ALT. 6 19/32" INT. 4 3/8" LG. 7"

FYD-085N

OEM:2106611X

GAFF:18002



SOPORTE P/EJE CARDAN SPICER 512- 281
ALT. 6 19/32" INT. 4 3/8" LG. 7"

EPO-117720

OEM:5003325

GAFF:11772



SOPORTE PARA EJE CARDAN SPICER

FYD-117720N

OEM:5003325

GAFF:11772



SOPORTE PARA EJE CARDAN SPICER

EPO-2079

GAFF:32079



BUJE P/BARRA ESTABILIZADORA SCANIA BUS
 ID: 2 5/16" LG: 4 1/8" H: 3 3/16"

EPO-221

OEM:469081

GAFF:32037



GOMA P/BARRA ESTABILIZADORA SCANIA BUS
 EXT.3 1/8" EXT.< 2 25/32" INT.1 3/4" ALT.2 15/16" LG. 4"

EPO-359

OEM:0295751

GAFF:32005



BUJE P/ BARRA ESTABILIZADORA SCANIA BUS, VOLVO BUS
 ALT. 3 3/4" INT. 2" ANCHO 4 1/4" LG. 3 7/8"

EPO-841

OEM:1104335

GAFF:32007



BUJE P/TENSOR MAN BUS, VOLVO BUS, SCANIA BUS
 EXT. 3 5/16" HO. 3/4" LG. C.C 5 1/8"

EPO-2028

OEM:0228483

GAFF:32028



BUJE P/BARRA ESTABILIZADORA SCANIA BUS
 ID: 1 31/32" LG: 4" H: 3 1/32"

EPO-2083

OEM:271187

GAFF:32083



GRANADA P/SUSP. SCANIA, BUS
 EXT. 2 15/16" HO 21/32 C.C 4 17/32

EPO-2044

OEM:362385

GAFF:32044



BUJE P/MUELLE SCANIA BUS MOD. G93/P93
 OD: 2 11/16 ID: 1 3/16" LG: 4 3/32"

EPO-2086

GAFF:32086



GRANADA P/SUSP. SCANIA, BUS IRIZAR 15, 16 Y PB
 EXT. 2 5/32" HO 19/32 C.C 3 9/16

EPO-2502

GAFF:32502



BUJE PARA MUELLE SCANIA BUS IRIZAR 15, 16 PB
 OD: 2 9/16" ID: 1 3/16" LG: 4"

EPO-31087

OEM:274070

GAFF:31087



GRANADA P/SUSP. SCANIA BUS, VOVO BUS F10,F12,F16
 EXT. 2 15/16" HO.21/32" C.C 5 1/8"

VOLKSWAGEN BUS

EPO- 057

OEM:1134955

GAFF:31053



BUJE P/ BARRA ESTABILIZADORA VOLKSWAGEN BUS
EXT. 1 1/2" INT. 5/8" LG. 1 7/8"

EPO- 8776

GAFF:18776



BUJE P/BARRA ESTABILIZADORA VOLKSWAGEN BUS
OD: 1 19/32" ID: 9/16" LG: 2 1/32"

EPO- 856

OEM:TAP511181

GAFF:40288



BUJE P/MUELLE VOLKSWAGEN BUS WORKER
EXT. 2 1/4" INT. 1 3/16" LG. 3 1/2"

FYD- 361N

OEM:3605040012

GAFF:31006



SOPORTE PARA ESCAPE VOLKSWAGEN BUS
EXT. 2 3/4" LG. 2 15/16" TORN. 10 MMX 1.5 MM

EPO- 844



BUJE P/ SUSP. WOKER
EXT. 56MM INT. 33MM LG. 55MM

FYD- 1303N



BUJE P/MUELLE DELANTERA VOCHO BUS
EXT. 53.5MM INT. 16MM LG. 88.5MM

WATSON CHALIN

EPO- 1536

OEM:147426

GAFF:11536



BUJE P/SUSPENSION DE AIRE WATSON CHALIN,WCTA-2590
OD: 3 11/16" ID: 27/32" LG: 2 1/2" OD<: 2 1/4"

EPO-990

OEM:3028448

GAFF:12320



BUJE P/BARRA ESTABILIZADORA VOLVO BUS
EXT. 3 1/2" INT. 1 15/16" LG. 3 3/4"

EPO-056

OEM:MP710903

GAFF:31051



GOMA P/BARRA ESTABILIZADORA VOLVO BUS
EXT. 2 5/16" INT. 1 3/4" LG. 2 3/8"

EPO-359

OEM:0295751

GAFF:32005



BUJE P/ BARRA ESTABILIZADORA VOLVO BUS
ALT. 3 5/32" INT. 2" ANCHO 4 1/4" LG. 3 7/8"

EPO-071

GAFF:31057



GOMA P/BARRA ESTABILIZADORA VOLVO BUS
EXT. 2 9/32" EXT.< 1 3/8" INT. 13/16" ALT. 1 1/32"

EPO-443

OEM:1617228000

GAFF:31594



GOMA P/ BARRA ESTABILIZADORA MERCEDES BENZ
EXT. 2 5/8" INT. 1 5/8" LG. 2 3/8"

EPO-2343

GAFF:12343



SOP. P/RADIADOR VOLVO BUS MULTEGO OC 500 (05-07)
OD: 2" ID: 3/8" LG: 1 5/8"

EPO-30516

OEM:17/1550

GAFF:30516



SOPORTE TRASERO P/MOTOR MCI BUS, VOLVO BUS.
OD: 5 19/32" ID: 1" LG: 6 25/32" WD: 5 29/32"

EPO-293

OEM:1697732

GAFF:31002



BUJE P/AMORTIGUADOR VOLVO BUS
OD: 2 3/8" ID: 13/16" LG: 1 17/32" OD<: 1"

EPO-059

OEM:H6012485

GAFF:31001



BUJE P/ BARRA ESTABILIZADORA VOLVO BUS
EXT. 2 1/8" EXT.< 2" INT. 9/16" LG. 1 9/16"

EPO-447

GAFF:31031



BUJE P/COMPRESOR VOLVO BUS
EXT. 1 1/4" INT. 9/16" LG. 1 13/16"

EPO-515

OEM:1135080

GAFF:31016



BUJE P/BARRA DE TORSION VOLVO BUS
EXT. 3 5/8" INT. 2 1/16" LG. 3 3/8"

EPO-993

OEM:20533294

GAFF:12338



BUJE P/BARRA ESTABILIZADORA VOLVO BUS
EXT. 2 1/32" INT. 25/32 LG. 4 3/8"

EPO-356

OEM:1598588

GAFF:31000



GRANADA P/BARRA DE TORSION VOLVO BUS / BUSSCAR
EXT. 3 5/8" BARR. 9/16" C-C. 4 15/16"

EPO-841

OEM:1104335

GAFF:32007



GRANADA P/TENSOR VOLVO BUS, SCANIA BUS
EXT. 3 5/16" HO. 3/4" LG. C.C. 5 1/8"

EPO-781

OEM:274069

GAFF:32009



KIT DE REPARACION BARRA ANGULAR VOLVO BUS
OD: 3 9/16" LG: 2 27/32 HO: 7/8" Bolt: 3/4-16 NF

EPO-1003

OEM:81432706079

GAFF:32008



GRANADA P/BARRA DE TORSION VOLVO BUS (1985-2009)
OD: 3 23/32" HO: 15/16" LG C-C: 6"

EPO-2345

OEM:1135080

GAFF:12345



BUJE P/BARRA DE TORSION VOLVO BUS 9800
OD: 3 5/8" HO: 21/32" LG C-C: 5 1/8"

EPO-2088

OEM:20840815

GAFF:32088



GRANADA P/SUSP. VOVO TRUCK
EXT. 3 11/32" HO.3/4" C.C 5 1/8"

EPO-2316

OEM:1620750

GAFF:12316



GRANADA P/BARRA ESTABILIZADORA VOGO BUS B7/B12
OD: 2 9/32" HO: 37/64" LG C-C: 3 13/16"

EPO-31087

OEM:274070

GAFF:31087



GRANADA P/SUSP. SCANIA BUS, VOVO BUS F10,F12,F16
EXT. 2 15/16" HO.21/32" C.C 5 1/8"

EPO-813

OEM:7037217

GAFF:12331



BUJE P/BARRA ESTABILIZADORA VOLVO
EXT. 3 31/32" INT. 2 1/4" LG. 3 3/4"

EPO-814

GAFF:12330



BUJE P/BARRA ESTABILIZADORA VOLVO
EXT. 3 23/32" INT. 2 1/8" LG. 3 3/4"

EPO-883

OEM:1135109

GAFF:12321



BUJE P/BARRA ESTABILIZADORA VOLVO BUS
EXT. 3 1/2" INT. 45 MM" LG. 3 3/4"

EPO-990

GAFF:12320



BUJE P/BARRA ESTABILIZADORA VOLVO
EXT. 3 1/2" INT. 1 15/16" LG. 3 3/4"

EPO-148H

OEM:507569C91

GAFF:10075



SOPORTE P/MOTOR VOLVO TRUCK, INTERNATIONAL
EXT. 3" INT. 1 1/2" LG. 3"

EPO-532

GAFF:18125



SOPORTE TRASERO P/MOTOR VOLVO
EXT. 2 3/4 LG. 4 7/8 ALT. 3" TORN. 1/2 NC

EPO-478

OEM:120050002

GAFF:12305



SOPORTE DELANTERO P/MOTOR VOLVO TRUCK
EXT. 2 13/16" EXT.< 2 3/8 INT. 21/32" ALT. 1 1/8"

EPO-432

OEM:049009997

GAFF:12301



SOPORTE TRAS. P/MOTOR VOLVO TRUCK, WESTERN STAR
INT. 5/8" C.C. 3" LG. 6 1/4" X 3" ALT. 1 1/4"

EPO-355

GAFF:31026



SOPORTE DE RADIADOR VOLVO
EXT. 2 5/16" INT. 1/2" LG. 2"

EPO-818

OEM:8074666

GAFF:31142



SOPORTE P/CABINA VOLVO TRUCK VNL 630 (2008)
EXT. 2 11/16 INT. 23/32" LG. 4 7/32"

EPO-818A

OEM:8074666

GAFF:31142



SOPORTE P/CABINA VOLVO TRUCK MOD.VNL630 (2008)
EXT. 2 11/16 INT. 23/32" LG. 4 1/4"

EPO-034

OEM:R307528

GAFF:18010



GOMA AMORTIGUADOR VOLVO TRUCK
EXT.1 1/2" INT. 3/4"

EPO-1109

GAFF:31109



BUJE P/BARRA DE TORSION DE CABINA VOLVO TRUCK
OD: 1 5/16" ID: 9/16" LG: 2 5/8"

EPO-1108

GAFF:31108



BUJE P/BARRA DE TORSION DE CABINA VOLVO TRUCK
OD: 1 5/16" ID: 9/16" LG: 1 29/32"

EPO-081A

OEM:6803220150

GAFF:31134



BUJE P/MUELLE VOLVO TRUCK
EXT. 2 1/4" INT. 25/32" LG. 4 1/4"

EPO-2348

OEM:20733583

GAFF:12348



BUJE P/MUELLE VOLVO TRUCK
OD: 2 13/32" ID: 7/8" LG: 4 5/8"

EPO-818A

OEM:8074666

GAFF:12340



SOPORTE P/CABINA VOLVO TRUCK MOD.VNL630 (2008)
EXT. 2 11/16 INT. 23/32" LG. 4 1/4"

EPO-132A

OEM:09729-01

GAFF:15013



BUJE P/TENSOR VOLVO TRUCK, REYCO, HENDRICKSON
EXT. 1 15/16" INT. 7/8" LG. 3"

EPO-357



BUJE P/BARRA ESTABILIZADORA VOLVO
EXT. 2 9/64" INT. 9/16" LG. 1 21/32"

FYD-69319

OEM:20769319

GAFF:12344



SOPORTE PARA CABINA VNL 630 VOLVO TRUCK (2008)

EPO-155

OEM:151087148

GAFF:13522



GRANADA BARRA DE TORSION, VOLVO TRUCK, PETERBILT
EXT. 2 17/32" HO 21/32 C-C 4 3/8"

EPO-290



GRANADA DE BOLA PARA VOLVO
EXT. 2 5/8" BARR. 23/32" C-C 4 3/8"

EPO-1018

OEM:8152450

GAFF:31093



GRANADA P/TENSOR VOLVO TRUCK
EXT. 3 19/32" HO 21/32 LG C-C. 4 17/32"

EPO-1135

OEM:3093630

GAFF:31135



GRANADA P/SUSP. VOLVO TRUCK
EXT. 2 15/16" HO.3/4" C.C. 5 1/8"

EPO-31144

OEM:20703083

GAFF:31144



COJINETE P/ DESGASTE VOLVO TRUCK MOD: AIR RIDE 2006
LG. 2 7/8" ALT. 1 5/8"

FYD-31141N

OEM: 20499003/ 4

GAFF: 31141



BUJE P/ BISAGRA DE COFRE VOLVO TRUCK MOD: VNL
EXT. 2 7/16" INT. 1" ALT. 31/32"

EPO-31129

OEM:20830479

GAFF:31129



BUJE P/MUELLE VOLVO TRUCK
OD: 2 17/32" ID: 7/8" LG: 3 17/32"

FYD-31129N

OEM:20830479

GAFF:31129



BUJE P/MUELLE VOLVO TRUCK
OD: 2 17/32" ID: 7/8" LG: 3 17/32"

EPO-069H

OEM:J7165-1

GAFF:11522



SOPORTE P/RADIADOR WESTERN STAR, FREIGHTLINER,
KENWORTH, PETERBILT
EXT. 2 15/16" EXT.< 1 13/16" INT.5/8" ALT. 1 1/4"

EPO-069AH

OEM:K066-228

GAFF:11523



SOPORTE P/RADIADOR, CABINA, MOTOR. WESTERN STAR
EXT.: 2 7/8" EXT.<: 1 13/16" INT: 5/8" ALT: 1 5/16"

EPO-465

OEM:K066-336

GAFF:11533



SOPORTE P/ CABINA WESTERN STAR, KENWORTH
EXT. 3" EXT.< 1 13/16" INT. 5/8" ALT. 1 15/16"

EPO-159H

OEM:K066-176

GAFF:11705



SOPORTE P/CABINA WESTERN STAR, KENWORTH. T-800
EXT. 3" EXT.< 1 13/16" INT 5/8" ALT. 2 3/8"

EPO-432

OEM:49009997

GAFF:12301



SOPORTE TRASERO P/MOTOR WESTERN STAR, VOLVO
LG. 6 1/4" ANCHO 3" HO. 5/8" ALT. 1 1/4"

EPO-098H

OEM:660551

GAFF:18102



SOPORTE DELANT. P/MOTOR WESTERN STAR, KENWORTH
EXT. 3 5/8" EXT. 2 3/16" INT. 3/4" ALT. 2 15/32"

EPO-178A

OEM:373023403

GAFF:30507



BUJE P/AMORTIGUADOR WESTERN STAR, KENWORTH.
EXT. 1 15/16" ALT. 1" INT. 1"

FYD-368N

OEM:A1615773000

GAFF:31624



SOPORTE P/MUELLE WESTER STAR, FREIGHTLINER
ALT. 3" ANCHO 2 7/8" LG. 4 3/8"

FYD-456N

OEM-9513510291

RB-413

EPO-872



BUJE P/MUELLE DELANTERA
ISUZU NPR (1995-2010)
EXT. 42 mm INT. 16 mm

EPO-874

OEM-941185881

RB-414



BUJE P/ MUELLE TRASERA.
ISUZU NPR
EXT. 40.2 mm INT. 16.2 mm

EPO-9708

OEM-8941133230



BUJE INFERIOR DELANT. TRAS.
ISUZU NKR-NPR
EXT. 40 mm INT. 22 mm

EPO-9708/0327

OEM-89411332



BUJE INFERIOR DELANTERO TRASERO.
ISUZU NKR (2013)
EXT. 43.5 mm INT. 22 mm

EPO-1019

OEM-89411332



BUJE INFERIOR DELANT. TRAS.
ISUZU NKR
EXT. 43.5 mm INT. 22 mm

EPO-1005

OEM-RB-414



BUJE P/ MUELLE ISUZU NPR
EXT. 1 9/16" INT. 5/8" LG. 1 3/4"

EPO-1020



BUJE IZUSO CAMIONCITO
EXT. 38 MM INT. 16 MM
LG. 41 MM

FYD-4001N

OEM-89411332

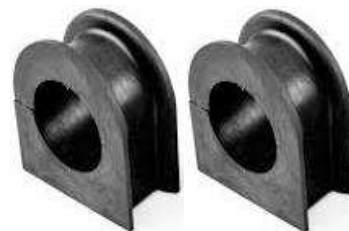

GOMA BARRA ESTABILIZADORA DELANTERA ISUZU
(02-03) INT. 45.5 mm

FYD-ELF300N

KFL1360

OEM-8944407900



GOMA BARRA ESTABILIZ. CAMION
ISUZU NPR, NQR CHATO (2012-2015)
EXT. 50mm INT. 40 mm LG. 60 mm

FYD-ELF301N

OEM-8944407930



GOMA BARRA ESTABILIZ. CAMION
ISUZU NPR, NQR CHATO (2012-2015)
EXT. 50mm INT. 30 mm LG. 60 mm

FYD-71626N

PHM-7-1626



TOPE SOBRE MUELLE DELANTERO ISUZU FL-300

FYD-959N



GOMA P/SOBRE MUELLE DELANTERO ISUZU FL-300

FYD-1056N

OEM-8941199581

TTP9298



**SOPORTE PARA SUSPENSION DE DESGASTE DE PERCHA
MUELLE CAMION ISUZU ELF**

FYD-521N

OEM-8972543870

TT14670



**SOPORTE PARA SUSPENSION DE DESGASTE DE PERCHA
MUELLE CAMION ISUZU NPR/NKR**

EPO-771



TAPON P/TAPAS DE REMOLQUES

EPO-772

OEM:248579

GAFF:17534



GOMAS PARA MANITAS, SELLO P/CONEXIÓN DE AIRE
OD: 1 5/8" ID: 5/8" TK: 3/8"

EPO-773



EPO-774



FYD-1301N

PARBO:PBC10174



SOPORTE UNIVERSAL P/RADIADOR
EXT.= 1 1/4" EXT.<= 3/4" INT. 7/16" LG. 1 7/16

FYD-171

GAFF:18005



BANDERIN SE SEÑALAMIENTO

EPO-181



TOPE UNIVERSAL
EXT. 2" TORN. 3/8" NF.

FYD-181N



TOPE UNIVERSAL
EXT. 2" TORN. 3/8" NF.

EPO-244

GAFF:11611



BUJE P/PALANCA DE VELOCIDADES FULLER
EXT. 1 33/64" INT. 7/8" ALT. 2 3/8"

EPO-076

GAFF:18778



REPUESTO P/ PALANCA DE CAMBIOS SPICER
EXT. 133/64" INT. 27/32" ALT. 2 9/32"

FYD-272N



SOPORTE P/RADIADOR VARIOS
 EXT. 2 5/16" ALT. 1 7/16"

FYD-8316N

GAFF:18316



TOPE PARA SUSPENSION VRMS BUS
 OD: 2 7/16" LG: 2 3/4" THD: M10X1.5

EPO-519



COJIN P/MUELLE

EPO-087

OEM:162426

GAFF:17506

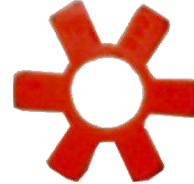

ACOPLE P/BOMBA DE INYECCION CUMMINS/V12
 EXT. 2 1/16" INT. 3/4" ESP. 7/16"

EPO-088

GAFF:17511

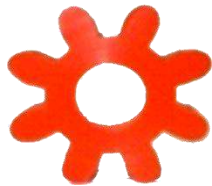

COPLE CHICO DE COMPRESOR PERKINS F-1
 EXT. 2 13/16" INT. 15/16" ESP. 23/32"

EPO-089

GAFF:17518

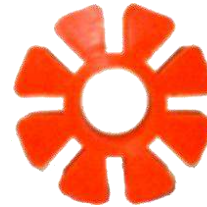

COPLE DE COMPRESOR MEDIANO PERKINS F-2
 EXT. 3 3/8" INT. 1 1/4" ESP. 29/32"

EPO-090

OEM:2581111

GAFF:17507

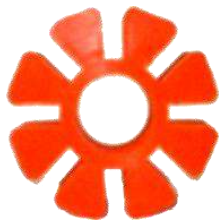

ACOPLE P/BOMBA DE INYECCION CUMMINS.
 EXT. 3 3/8" INT. 1 1/4" ESP. 1 9/32"

EPO-158

GAFF:17541



JGO. DE GAJOS MEDIANOS P/COMPRESOR PERKINS
 ALT. 3/4" ANCHO 7/8"

EPO-158A

GAFF:17508



JGO. DE GAJOS GRANDES P/COMPRESOR 2005
 ALT. 1 1/4" ANCHO 15/16"

EPO-297



ESTRELLA INDUSTRIAL PARA COPLE
 EXT. 3 1/4" ESPESOR. 3/4"

EPO-068



SOPORTE P/CABINA USO VARIOS
 EXT. 2 1/2" INT. 5/8" ALT. 7/8"

FYD-314N

GAFF:18290



TAPON P/TANQUE DIESEL
 EXT. 1 27/32" EXT. < 1 7/16 INT. 3/8 ALT. 1 7/16"

EPO-301

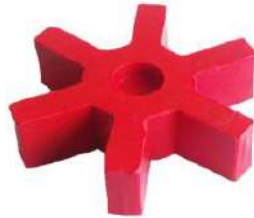

ESTRELLA INDUSTRIAL PARA COPLE
 EXT. 4 1/2" ESPESOR. 1"

EPO-302

GAFF:17508



ESTRELLA INDUSTRIAL PARA COPLE
 EXT. 5 1/4" ESPESOR. 1"

EPO-1094EDG



BUJE PARA SUSPENSIÓN
 EXT. 3 5/16" INT. 3/4" LG. 3 1/16"

FYD-1015N



BUJE PARA MUELLE REMOLQUITO
 EXT. 18.5 INT. 15.5 LG. 44.5

EPO-23456



SOPORTE P/ ENGRANE CUBA

EPO-8700

OEM:SP7165X1

GAFF:18700



BUJE PARA BALANCIN VRMS
 OD: 2 11/16" ID: 1 3/16" LG: 4 3/32"

CALZAS PARA CASETA

EPO-1017



EXT. 70mm

BUJE
INT. 12 mm LARGO. 60mm

EPO-1032



EXT. 70mm

BUJE
INT. 12mm LARGO. 90mm

EPO-232

STAR:6071



GOMA PARA CASETA, CHASIS UNIVERSAL
EXT. 2 3/8" INT. 5/8" ALT. 1"

FYD-6071N

STAR:6071



GOMA PARA CASETA, CHASIS UNIVERSAL
EXT. 2 3/8" INT. 5/8" ALT. 1"

EPO-172

GAFF:1155

STAR:6072



BUJE ANTIVIBRADOR KENWORTH
EXT. 2 7/8" INT. 5/8" ESP. 1"

FYD-6072N

STAR:6072

EPO-172



GOMA P/CASETA MEDIANA (172)
EXT. 3" INT. 5/8" ALT. 1"

EPO-173

STAR:6073



GOMA P/CASETA GRANDE (173)
EXT. 3" INT. 3/4" ALT. 1 1/2"

FYD-6073N

STAR:6073

EPO-173



GOMA P/CASETA GRANDE (173)
EXT. 3" INT. 3/4" ALT. 1 1/2"

EPO-173A

STAR:6074



GOMA P/CASETA UNIVERSAL EXTRA GRANDE
EXT. 3" INT. 3/4" ESP. 2"

FYD-6074N

STAR:6074

EPO-173A



GOMA P/CASETA UNIVERSAL EXTRA GRANDE
EXT. 3" INT. 3/4" ESP. 2"

CALZAS PARA CASETA

EPO-224

STAR:0702



GOMA CASETA INTERMEDIA CHICA
EXT. 2 7/8" INT. 9/16" ALT. 3/4"

EPO-229



GOMA PARA TENSOR DE RADIADOR VARIOS
EXT. 1 5/8" INT. 5/8" ESPESOR 1/2"

FYD-702N

STAR:0702

EPO-224



GOMA CASETA INTERMEDIA CHICA
EXT. 2 7/8" INT. 9/16" ALT. 3/4"

FYD-703N

STAR703



GOMA CASETA INTERMEDIA GRANDE
EXT. 3 15/16" INT. 1/2" ALT. 1/2"

FYD-173A4N



SOPORTE REDILA DE CAMION
EXT. 4" INT. 3/4" 1 1/2"

G A N C H O S

FYD-848N

GAFF:10506



GANCHO DE COFRE
INTERNATIONAL LARGO 12"

FYD-849N

GAFF:10024



254 GANCHO P/COFRE DINA
.5 7/8"

FYD-854N

GAFF:11768



GANCHO DE COFRE MINI-BUS INT.
MERCEDES KENWORTH 10 3/4"

FYD-855N



257-C GANCHO DE COFRE LARGO
KENWORTH NUEVO 8 9/16"

FYD-894N



253-B BASE GANCHO VOLVO

TOPES VARIOS

FYD-807N

STAR:1064



TOPE P/DEFENSA CONICO 1064

FYD-808N

STAR:1087



TOPE P/DEFENSA PANAMERICANO 1087

FYD-810N

STAR:1066



TOPE P/DEFENSA DE FAMSA ESCALON 1066

FYD-811N

STAR:1065



TOPE P/DEFENSA FAMSA LISO 1065

FYD-820N

STAR:1062



TOPE P/DEFENSA MEDIO CONTENEDOR 1062

FYD-821N

STAR:1063



TOPE P/DEFENSA CONTENEDOR 1063

FYD-847N



TOPE TRIANGULAR

FYD-876N



TOPE FRUEHAUF

FYD-819N

STAR:1061



TOPE P/DEFENSA DE SEGURIDAD PLATAFORMA O CAJA
LG: 5 7/8" WD: 4 1/8" H: 3 5/16" HO: 9/16" LG C-C: 2 3/8"



¡VISITANOS!

 (55) 271 152 8194

 fydsa.admon@gmail.com

 FYDSA

 www.fab-fydsa.com.mx

SOPORTE A TU DESTINO